

AIPHONE

IS SERIES

Commercial & Security Video Intercom system

Local System

SETTING MANUAL

Thank you for selecting Aiphone for your communication and security needs. Please read this manual and the separate "OPERATION MANUAL" carefully before setting and using this system.

* Refer to the provided "INSTALLATION MANUAL" for complete information regarding this system.

IMPORTANT

Please read and understand the system setting procedures before beginning the setup process.

Please note that images and illustrations depicted in this manual may differ from the actual ones.

CONTENTS

ABOUT THIS MANUAL	3
PURPOSE OF THE SYSTEM SETTINGS	3
SETTING LIST	4
STARTING UP THE SYSTEM	8
System requirements for PC	8
Starting up the system	8
Setting the system configuration [System configuration]	9
MAKING THE SYSTEM SETTINGS	10
The basic setting procedure.....	10
Making network settings [Network setting]	11
Setting the administrator ID and password [Administrator setting].....	11
Registering areas [System setting – Area registration] (Required)	12
Registering zones [System setting – Zone registration]	12
Registering control units [System setting – Control units composition].....	12
Registering stations and PA outputs [System setting – Registering stations].....	13
Making detailed settings to stations and control units [System setting – Advanced station settings]	14
Basic setting procedure.....	14
Making detailed settings to door stations or room sub stations	14
Making detailed settings to master stations	15
Making detailed settings to the central control unit, add-on control unit(s) or room sub control unit(s)	16
Registering stations and PA outputs to zones [System setting – Zone setting]	17
Registering sound files for chime [Chime setting – Registering sound source]	17
Registering sound sequences [Chime setting – Registering sound sequences].....	18
Registering daily chime schedule [Chime setting – Registering daily chime schedule]	18
Setting chime schedule [Chime setting – Chime schedule setting].....	19
Registering daily transfer schedule [Transfer setting – Registering daily transfer schedule]	20
Setting transfer schedule [Transfer setting – Transfer schedule setting]	20
Setting the timer [Timer setting]... ..	21
Setting time and date [Time and date setting]	22
Downloading/uploading setting data [Setting file].....	22
■ When downloading setting data onto the PC	22
■ When uploading setting data	22
Updating the system [Updating the system]	22
MAINTENANCE	23
Initializing the system [Initialization].....	23
Downloading system log [System log]	23
Updating the firmware [Firmware update].....	23
■ Downloading updated firmware data ...	23
Referring to the troubleshooting guide [Troubleshooting].....	23
Registering your system [Registration]	23

ABOUT THIS MANUAL

The IS system provides various manuals to meet various system planning and work processes. Use the manuals necessary for your system.

Manual configurations

The following manuals are provided for a local system. Read all the manuals for installing, setting up, and using a local system, or provide the manuals to the persons working with the system.

* The INSTALLATION MANUAL includes the contents for a standard (IP) system.



INSTALLATION MANUAL (A booklet included with the central control unit)

Used for installing and connecting control units, stations and power supply unit. (For an installer or serviceman)



SETTING MANUAL (This manual on the CD-ROM included with the central control unit)

This manual describes how to make the system settings and system maintenance. (For an installer or serviceman)

OPERATION MANUAL (An electronic manual on the CD-ROM included with the central control unit)

Information for using the system for calling, communicating, paging, monitoring, etc. (For users of the system)

PURPOSE OF THE SYSTEM SETTINGS

After the installation and connections of all the components are completed, configure the system settings based on how your system is planned to be used. System settings must be completed before the system will operate.

CAUTION:

Make the settings correctly. If the settings are not made correctly, the system will not function as planned.

NOTE:

This manual is for setting a local system. To make settings for a standard (IP) system using an IP network, read the SETTING MANUAL for the standard (IP) system.

SETTING LIST

The following is the list of system settings you can make via the web browser. **The titles or items in shaded cells are required.**

NOTE:

The following list is a brief overview of the setting items available in the system settings on a PC. The descriptions, and the style and order of descriptions do not necessarily equate with the actual displays.

Title	Sub title	Item	Sub item	Setting range	Default	
(On the login window)	-	(Language)	-	English/French/German/Spanish/Dutch/Italian/Japanese	English	
System configuration	-	-	-	Local system/Standard system (IP system)	Local system	
Network setting		IP version	-	IPv4	IPv4	
		(Select the network setting method.)	-	DHCP/Static IP Address	DHCP	
		Static IP Address	Static IP Address (required when [Static IP Address] is selected)	0 – 255 (for each field)	192.168.0.30	
			Subnet Mask (required when [Static IP Address] is selected)	0 – 255 (for each field)	255.255.255.0	
			Default Gateway	0 – 255 (for each field)	-	
			Primary DNS Server	0 – 255 (for each field)	-	
			Secondary DNS Server	0 – 255 (for each field)	-	
			MAC address	-	(Unmodifiable)	(Unmodifiable)
			Unit name	-	Up to 24 alphanumeric characters (except accent marks, umlaut marks, etc.)	-
	Web port	-	(Unmodifiable)	(Unmodifiable)		
Administrator setting		New administrator ID	-	Up to 16 alphanumeric characters	-	
		Current Password	-	Up to 16 alphanumeric characters	- (aiphone)	
		New Password	-	Up to 16 alphanumeric characters	-	
		New Password (Re-type)	-	Up to 16 alphanumeric characters	-	
System setting	Area registration	Area name	-	Up to 24 alphanumeric characters (for up to 99 areas)	1 (for Area number 01)	
	Zone registration	Zone name	-	Up to 24 alphanumeric characters (for up to 99 zones)	-	
	Control units composition	Room sub control unit 1 to 4, Add-on control unit 1 to 2	-	Connected/Not connected	Not connected	
	Registering stations	Area (stations only)	-	(Area) 01 to 99	(Area) 01	
		Station number (stations only)	-	001 to 999 0001 to 9999 00001 to 99999	-	
		Station name (for stations)	-	Up to 24 alphanumeric characters	-	
		Station name (for PA output) (Required when an external unit is connected to the corresponding PA output terminals)	-	Up to 24 alphanumeric characters	-	
		Station type (sub stations only)	-	(Select from the registered ones.)	(Depends on the control unit.)	

Title	Sub title	Item	Sub item	Setting range	Default		
System setting	Advanced station settings	Video door station/Audio door station/ Room sub station	Called stations	Call priority	Normal/Priority/Urgent	Normal	
				Called stations	(Set up to 20 master stations from the registered ones.)	-	
			Contact input (room sub stations only)	Contact type	Normally open (NO) /Normally closed (NC)	Normally open (NO)	
				Call priority/Answering the page	Answering the page /Call (Normal/Priority/Urgent)	Normal	
			Other	Transmit volume boost at PTT	ON/OFF (ON: approx. +6dB up)	OFF	
				Camera zoom image preset (video door stations only)	0 (wide)/1/2/3/4/5/6/7/8/9 (zoom)	5 (Center)	
				Call acknowledge tone on/off	ON/OFF	ON	
				Backlight adjustment (video door stations only)	Exposure +/Exposure -	Exposure +	
				Speaker (room sub stations only)	Built-in speaker /External speaker	Built-in speaker	
			Master station	Stations to be scan monitored	(Select up to 20 sub stations from the registered ones.)	-	
				Other	Master station function: paging, chime, monitor, door release, and remote site call	ON/OFF	ON
			Central control unit	Contact input	(Contact input)	S1 to S4	S1
					Contact type	Normally open (NO) /Normally closed (NC)	Normally open (NO)
		Trigger condition			None/Broadcast chime/Stop chime	None	
		Sound source (Only when "Broadcast chime" is selected at "Trigger condition")			Internal sound source (Select a sound file or sequence name from the registered ones in the list.) /External sound source (Select either External sound source 1 or 2.)	-	
		Chime priority (Only when "Broadcast chime" is selected for "Trigger condition")			Normal/Priority/Urgent	Normal	
		Zone name (Only when "Broadcast chime" is selected at "Trigger condition")			(Select from the registered ones.)	-	
		(Contact output terminal)			L1 to L8	L1	
		Contact output		Contact type	Normally open (NO) /Normally closed (NC)	Normally open (NO)	
				Trigger condition	None/Calling notice/Door release /External sound source/PA output	None	
				Calling notice (Only when "Calling notice" is selected at "Trigger condition")	Normal: OFF/ON Priority: OFF/ON Urgent: OFF/ON	Normal: OFF Priority: OFF Urgent: OFF	
				Door release (Only when "Door release" is selected at "Trigger condition")	(Select from the sub stations registered and set for the central control unit.)	-	
				External sound source (Only when "External sound source" is selected at "Trigger condition")	External sound source 1 /External sound source 2	-	
				PA output (Only when "PA output" is selected at "Trigger condition")	PA output 1 to 4	-	

Title	Sub title	Item	Sub item	Setting range	Default	
System setting	Advanced station settings	Room sub control unit/ Add-on control unit	(Contact output terminal)	L1 to L4	L1	
			Contact type	Normally open (NO)/Normally closed (NC)	Normally open (NO)	
			Trigger condition	None/Calling notice/Door release/PA output	None	
			Calling notice (Only when "Calling notice" is selected at "Trigger condition")	Normal: OFF/ON Priority: OFF/ON Urgent: OFF/ON	Normal: OFF Priority: OFF Urgent: OFF	
			Door release (Only when "Door release" is selected at "Trigger condition")	(Select from the sub stations registered and set for each control unit.)	-	
			PA output (Only when "PA output" is selected at "Trigger condition")	PA output 1 to 4	-	
	Zone setting	Zone number	-	(Select from the registered ones.)	-	
			Stations	(Select from the list.)	-	
			PA output	(Select from the list.)	-	
	Chime setting	Registering sound source	(Sound file)	-	SF1 to SF15 (3MB in total, 2MB/file)	-
Registering sound sequences		Sound number	-	SS1 to SS20	SS1	
		Sound sequence name	-	Up to 24 alphanumeric characters	-	
		Step	-	1 to 10	1	
		Sound source	Sound file	(Select from the registered ones.)	-	
Repeat times			1 to 10	1		
Registering daily chime schedule		Schedule number	-	DS1 to DS10	DS1	
		Schedule name	-	Up to 24 alphanumeric characters	-	
		Chime time	-	Hour: 0 to 23 Minute: 0 to 59 Second: 0 to 59	-	
		Sound source	-	Sound file (Select from the registered ones.) /Sound sequence (Select from the registered ones.) /External sound source (1 or 2)	-	
			Zone number	-	(Select from the registered ones.)	-
		Chime priority	-	Normal/Priority/Urgent	Normal	
Chime schedule setting		Weekly schedule	(Repeat setting)	Every week/Every other week	Every week	
			Schedule start date	From the current day to 1 year ahead	-	
			Schedule end date	From the start day to 1 year ahead	-	
			(Chime schedule)	None/DS1 to DS10 (for each day of the week)	None	
		Individual schedule	(Date)	From the current day to 1 year ahead	-	
			Daily chime schedule	(Select from the registered ones.)	None	
			Chime time	Hour: 0 to 23 Minute: 0 to 59 Second: 0 to 59	-	
			Sound source	-	Sound file (Select from the registered ones.) /Sound sequence (Select from the registered ones.) /External sound source (1 or 2)	-
				Zone number	(Select from the registered ones.)	-
			Chime priority	Normal/Priority/Urgent	Normal	
	Schedule download		-	(Download the chime (and transfer) schedule data in CSV format.)	-	

Title	Sub title	Item	Sub item	Setting range	Default			
Transfer setting	Registering daily transfer schedule	Schedule number	-	DT1/DT2	DT1			
		Schedule name	-	Up to 24 alphanumeric characters	-			
		Call transfer time	-	Hour: 0 to 23 Minute: 0 to 59 (Set to the Start time and End time individually.)	-			
	Transfer schedule setting	Weekly schedule	(Repeat setting)		Every week/Every other week	Every week		
			Schedule start date		From the current day to 1 year ahead	-		
			Schedule end date		From the start day to 1 year ahead	-		
		(Transfer schedule)		None/DT1/DT2 (for each day of the week)	None			
		Individual schedule	(Date)		From the current day to 1 year ahead	-		
			Daily transfer schedule		(Select from the registered ones.)	None		
	Call transfer time			Hour: 0 to 23 Minute: 0 to 59 (Set to the Start time and End time individually.)	-			
Timer setting	-	Call	Normal/Priority/Urgent	10 to 600 (sec.), 0 (Unlimited)	Normal: 30 (sec.) Priority: 90 (sec.) Urgent: 0 (Unlimited)			
		Communication	In Local (local system only)	30 to 600 (sec.)	60 (sec.)			
		Paging	-	30 to 600 (sec.)	60 (sec.)			
		Monitor	-	10 to 600 (sec.)	60 (sec.)			
		Scan monitor: Switching	-	5 to 60 (sec.)	5 (sec.)			
		Contact output	External sound source 1		10 to 300 (sec.)	30 (sec.)		
			External sound source 2		10 to 300 (sec.)	30 (sec.)		
Door release	-	0 to 300 (sec.), (0: Released while holding the Door release button pressed.)	10 (sec.)					
Time and date setting	-	Set current time	Manual setting	Year: 2009 to 2099 Month: 1 to 12 Day: 1 to 31 Hour: 0 to 23 Minute: 0 to 59 Second: 0 to 59	(Internal time of the central control unit)			
			Synchronized with PC	-	-			
		NTP	Synchronized with NTP server		ON/OFF	OFF		
			NTP server* ¹		IP address or domain name	-		
			NTP port number* ¹		1 to 65535	123		
			(UTC time zone* ¹)		-12 to +13 (h)	0		
			Hour difference* ¹		-45/-30/0/+30/+45 (m)	0		
			Minute difference* ¹					
		Synchronize interval* ¹		1 to 240 (h)	24 (h)			
		Daylight savings time	-		ON/OFF	OFF		
			Starts* ²	Month		JAN to DEC (M)	JAN	
				Day	(Week)		1st to 4th (W)/The last	1st
					(Day)		Sunday to Saturday	Sunday
				Hour	(Hour)		0 to 23 (h)	-
					(Minute)		0 to 59 (m)	-
				Ends* ²	Month		JAN to DEC (M)	JAN
			Day		(Week)		1st to 4th (W)/The last	1st
(Day)					Sunday to Saturday	Sunday		
Hour	(Hour)				0 to 23 (h)	-		
	(Minute)				0 to 59 (m)	-		
Hour difference* ²		0 to 12 (h)	1					
Minute difference* ²		0/30/45 (m)	0					
Setting file	Downloading setting data	-	-	-	-			
	Uploading setting data	-	-	-	-			

*¹: Available only when [Synchronized with NTP server] is set to ON.

*²: Available only when [Daylight savings time] is set to ON.

STARTING UP THE SYSTEM

Before making the system settings, confirm that a PC is connected to the central control unit (IS-CCU). The system settings are made on the PC by accessing the web browser for the settings incorporated with the central control unit (IS-CCU).

System requirements for PC

Your PC and operating environment must meet the following system requirements to make the settings.

Network	10BASE-T Ethernet, 100BASE-TX Ethernet
Web browser	Internet Explorer 6.0 or later (with Internet Options SSL 3.0 enabled)

Starting up the system

1 Connect a PC to the central control unit.

[When connecting a PC to the central control unit via a router]

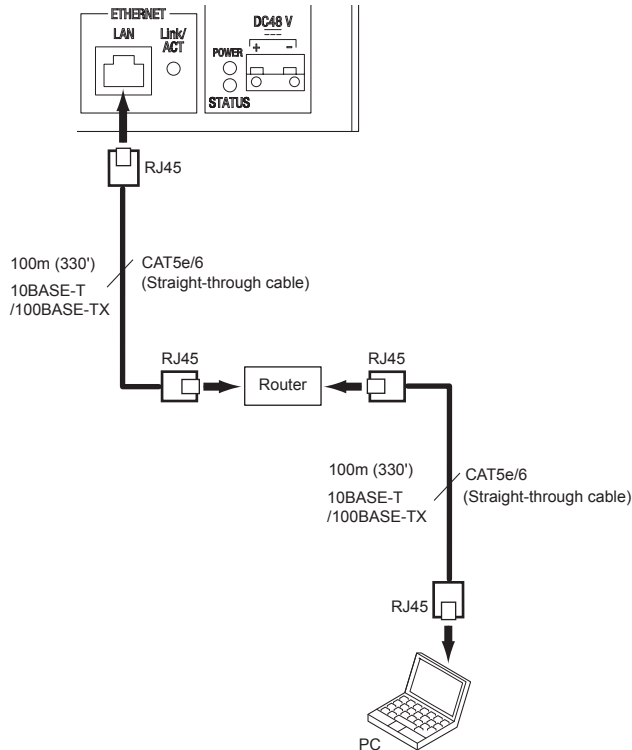

NOTES:

- Select this connection method when you will acquire an IP address automatically by DHCP. Do not select this connection method if your router does not have a DHCP server function.
- Be sure to connect the CAT5e/6 cable to the LAN ports of both units.

[When connecting a PC to the central control unit directly]

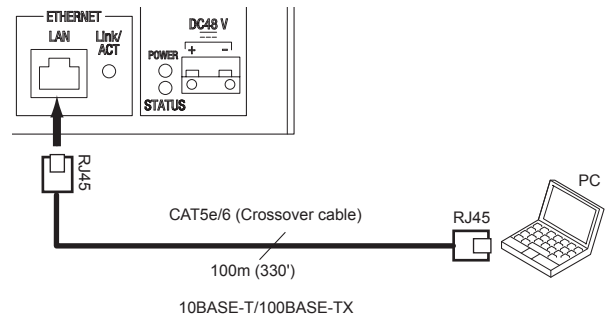

NOTES:

- Select this connection method when using a static IP address.
- When connecting a PC to the central control unit directly, use an Ethernet crossover cable.
- The IP address of central control unit is set to (192.168.0.30) as default. Change the IP address of your PC if needed.

- 2 Press down the "I" side of POWER switch to turn on all the control units in the system.

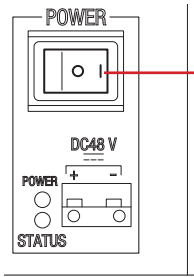

- POWER switch
- Press down "I" side to turn on the unit.
 - Press down "O" side to turn off the unit.



* Confirm that the following LEDs operate as shown below.

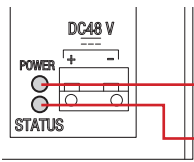

- Lights up.
- Blinks
(When the system settings have finished correctly, this LED turns from blinking (initializing) to lighting.)

- 3 Start up the PC, and then open the browser window.
- 4 Enter the **static IP address (https://192.168.0.30/)** or the IP address assigned by DHCP to access the web browser for settings.

* If you do not know your IP address assigned by DHCP, run "IS_IPSEARCH.exe" from the supplied CD-ROM, and then search for it.

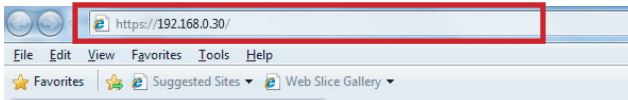

The login window of the web browser is displayed.

- 5 Log in to the system by setting the following items.

- **Select language**
Select the language for displaying contents on the setting windows.
- **ID**
Enter "aiphone".
- **Password**
Enter "aiphone".
- **Login**
Click **Login** to display the setting window.

* When you log in for the first time, the **[Registration]** window appears. Register your system as needed when the IS-CCU is connected to the IP network.

NOTE:

Be sure not to log in to the system more than once at the same time by opening multiple browser windows on the PC.

Setting the system configuration [System configuration]

After logging in to the system, the **[System configuration]** window appears.

First of all, make the setting on this window before starting the system settings.

- 1 Select your system between "Local system" and "Standard system (IP system)".
- 2 Click **Temporarily stored** to save the setting result temporarily. (→P. 10)
- 3 Start the system settings by selecting a setting title in the table of contents on the left side of the window.



Go to the next page.

MAKING THE SYSTEM SETTINGS

The basic setting procedure

When you have logged in to the system, the setting window appears. You can make the settings on this window.

- * **Make sure to refer to the on-screen instructions and comments displayed on each window when you make the settings.**
- * **Depending on the PC and its OS or environment, the display may differ.**

<Setting window example>

Setting contents display area

The setting items of the selected setting title and their details are displayed here.

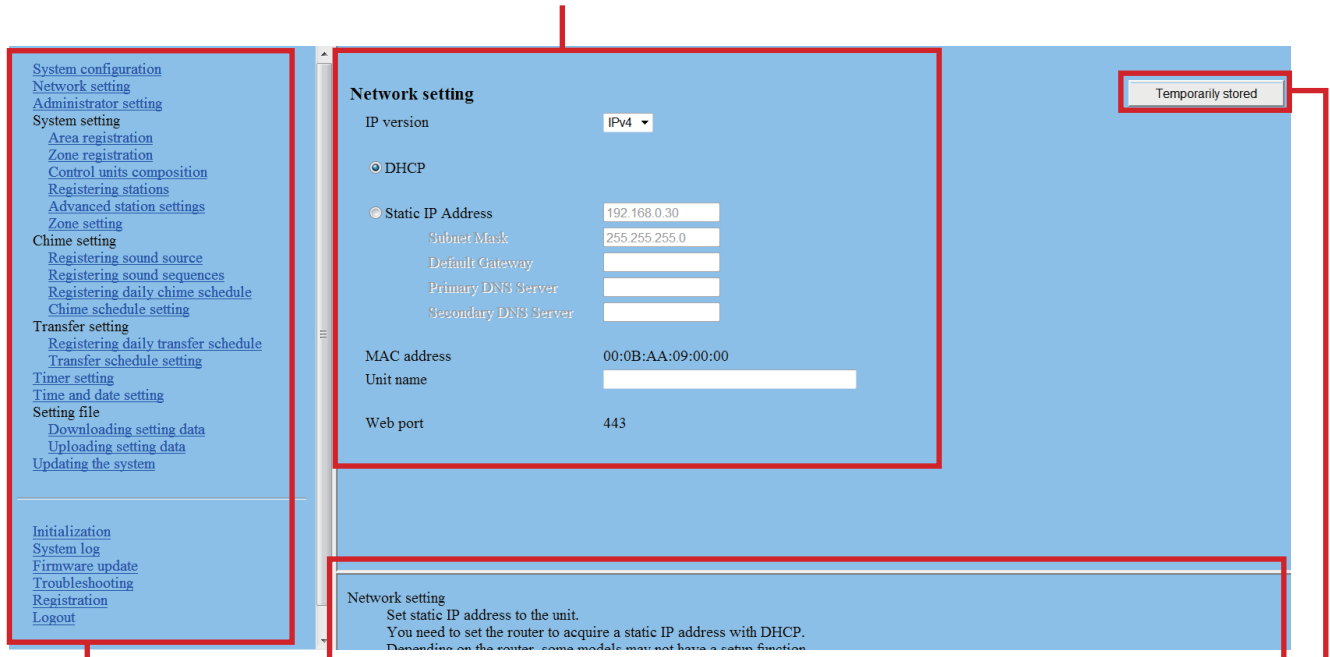

Table of contents

The setting titles are listed here. Click the title on which you want to make the settings to display the corresponding setting window.

Instructions area

The instructions for settings are displayed here.

Temporarily stored

Click this to save the current setting results temporarily.

* This temporary storing will not update the system with the new setting results. To update the system, click the title "Updating the system" and follow the necessary procedure.

The setting procedure

- 1 Click a title in the table of contents on which you wish to make the settings.
The setting window of the title is displayed.
- 2 Make the settings on the setting items individually.
- 3 When you have finished making the settings on the current window, click **Temporarily stored** to save the setting results temporarily.
 - * If you wish to cancel the setting results you have made, click a title in the table of contents or "Refresh" in the web browser menu. (If you change the current window to another without storing the setting results temporarily, a pop-up window appears asking if you want to store the results temporarily or not.)
- 4 Repeat step 1 to 3 to make the settings on the other titles.

* To log out of the system, click **[Logout]** in the table of contents.

The following shows the setting procedure for the items of each title.
Refer to "SETTING LIST" (→P. 4-7) for details about the settings. Make the settings by also referring to the on-screen instructions.

Making network settings [Network setting]

Make the settings for network according to your requirements.

- 1 Click **Network setting** in the table of contents.

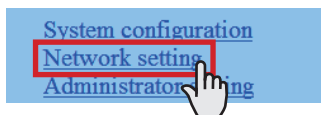

- 2 Make the settings on the following items displayed in the setting window.

Selecting the network setting method

Set a (static) IP address to this unit. Select the method for acquiring a (static) IP address between [DHCP] and [Static IP Address].

- **[DHCP]:**

Check this when you will acquire an IP address with DHCP.

* A DHCP server (or a router) is required to acquire an IP address with DHCP. A router may not have the setup function depending on some models. For information about setting a router, see the instruction manual for the router.

- **[Static IP Address]:**

Check this when you do not use a DHCP server (or a router) or connect the PC to the central control unit directly, and then enter the static IP address, subnet mask, etc.

* **It is required to enter the static IP address and subnet mask.**

- **[Unit name]:**

Enter a name for this unit. (This name will not be used when operating the system.)

NOTE:

The items that cannot be changed or selected are grayed out.

- 3 Click **Temporarily stored** to save the current setting results temporarily.

* If you wish to cancel the setting results you have made, click a title in the table of contents or "Refresh" in the web browser menu.

Setting the administrator ID and password [Administrator setting]

We recommend that you change the administrator ID and password from default to unique ones for security purposes.

* "aiphone" is preset as the default for both ID and password.

- 1 Click **Administrator setting** in the table of contents.

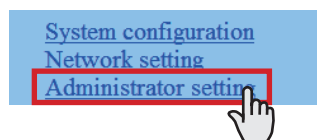

- 2 Make the settings on the following items displayed in the setting window.

- **[New administrator ID]:**

Enter the new ID.

- **[Current Password]:**

Enter the current password.

- **[New Password]:**

Enter a new password.

- **[New Password (Re-type)]:**

Enter the new password again.

- 3 Click **Temporarily stored** to save the current setting results temporarily.

* If you wish to cancel the setting results you have made, click a title in the table of contents or "Refresh" in the web browser menu.

NOTE:

The system administrator must keep the ID and password without fail. If you forget the ID and password, you must initialize the unit, thus all the setting contents return to default.

Registering areas

[System setting – Area registration] **Required**

Register areas for separating stations in the system. The number to which a name is entered is registered as an area number. Up to 99 areas can be registered.

- 1 Click **Area registration** in the table of contents.

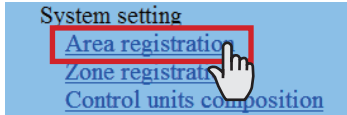

- 2 Enter an area name in the cell for the area number 01.

* The figures under "Number" in the tables means the area numbers.

- 3 Enter area names in the cells for other numbers to register more areas.

- 4 Click **Temporarily stored** to save the current setting results temporarily.

* If you wish to cancel the setting results you have made, click a title in the table of contents or "Refresh" in the web browser menu.

NOTES:

- Be sure to register at least one area to the area number 01. ("1" is entered in the cell for the area number 01 as default.)
- A call number displayed on the master station monitor consists of an area number plus a station number.

Registering zones

[System setting – Zone registration]

Register zones for paging (transmitting announcements and chime). The number to which a name is entered is registered as a zone number. Up to 99 zones can be registered.

* Zones are groups of stations designated for paging and chime paging.

- 1 Click **Zone registration** in the table of contents.

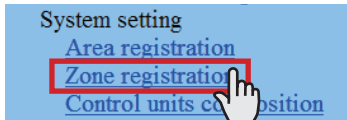

- 2 Enter a zone name in the cell for the target zone number.

* The figures under "Number" in the table means the zone number.

- 3 Enter zone names in the cells for other numbers to register more zones.

- 4 Click **Temporarily stored** to save the current setting results temporarily.

* If you wish to cancel the setting results you have made, click a title in the table of contents or "Refresh" in the web browser menu.

Registering control units [System setting – Control units composition]

Register all the control units connected to the central control unit.

- 1 Click **Control units composition** in the table of contents.

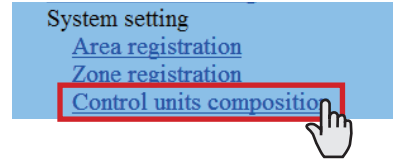

- 2 Click to check the radio button under "Connected" for the unit you will register.

	Connected	Not connected
	<input checked="" type="radio"/>	<input type="radio"/>
	<input checked="" type="radio"/>	<input type="radio"/>

* Click **Connection check** to confirm the connected units.

Connected: yellowish green

Not connected: gray

Shows a port no. of the central control unit to connect with a room sub control unit or add-on control unit.

Central control unit	
1CX	Room sub control unit ID1
2CX	Room sub control unit ID2

Shows the ID setting of the room sub control unit or add-on control unit set by the ID setting switches. (Refer to the INSTALLATION MANUAL for details.)

- 3 Click **Temporarily stored** to save the current setting results temporarily.

* If you wish to cancel the setting results you have made, click a title in the table of contents or "Refresh" in the web browser menu.

Registering stations and PA outputs [System setting – Registering stations]

Register all the stations and PA outputs connected in the system, and set the area, station no., station name (or PA output name) and type of station (for sub stations: video door/ audio door/room sub stations) to them.

- 1 Click **Registering stations** in the table of contents.

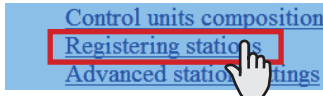

- 2 Set the area, station no., station name and type of station (for sub stations) to the target stations, and enter names to the target PA outputs.

- * **Setting the station no. is required.**

- * Shows a port no. of the control unit to connect with a station.

<input checked="" type="checkbox"/>	Central control unit
<input type="checkbox"/>	D1 01 1
<input type="checkbox"/>	D2 01 1
<input type="checkbox"/>	D3 01 1
<input type="checkbox"/>	D4 01 1
<input type="checkbox"/>	M1 01 1

- * **It is required to enter a name to the target PA output when an external unit is connected to the corresponding PA output terminals.**

- * For a cell with the mark, select the target one from the pull-down menu.

- * Do not set stations with the same number in an area.

NOTE:

The name of a master station displayed on its monitor in standby mode is up to 16 alphanumeric characters.

Other buttons

- **Connection check**
Click to confirm the connected units.
Connected: yellowish green
Not connected: gray
Station type error: pink

- **[Collective setting]:**

The following buttons are used to make the settings to all the checked stations at one time.

- * Pressing each button opens another window.

NOTE:

Be sure to check all the target stations before using these buttons.

- **Area**
Click to set the same area number to all the checked stations.

- **Station number**
Click to assign sequential numbers to all the checked stations from top to bottom. The number you enter will be set as the first number and will be assigned to the top station of the ones checked. Other checked stations will be numbered sequentially.
- **Station name**
Click to assign the same station (and/or PA output) name and sequential numbers to all the checked stations (and/or PA outputs) from the top down. Enter a name only.
- **Station type** (sub stations)
Click to set the same station type to all the checked sub stations.

How to select multiple stations

- Click to check the stations and PA outputs you will register.

<input checked="" type="checkbox"/>	Central control unit
<input checked="" type="checkbox"/>	D1 01 1
<input checked="" type="checkbox"/>	D2 01 1
<input type="checkbox"/>	D3 01 1
<input type="checkbox"/>	D4 01 1

- By clicking the button for the control unit, all the stations and PA outputs connected to it are checked or canceled.

<input checked="" type="checkbox"/>	Central control unit
<input checked="" type="checkbox"/>	D1 01 1
<input checked="" type="checkbox"/>	D2 01 1
<input checked="" type="checkbox"/>	D3 01 1
<input checked="" type="checkbox"/>	D4 01 1

- By clicking the button on the top of the list, you can check or cancel all the stations and PA outputs on the list.

<input checked="" type="checkbox"/>	Area
<input checked="" type="checkbox"/>	Central control unit
<input checked="" type="checkbox"/>	D1 01 1
<input checked="" type="checkbox"/>	D2 01 1
<input checked="" type="checkbox"/>	D3 01 1
<input checked="" type="checkbox"/>	D4 01 1

- 3 Click **Temporarily stored** to save the current setting results temporarily.

- * If you wish to cancel the setting results you have made, click a title in the table of contents or "Refresh" in the web browser menu.

Making detailed settings to stations and control units [System setting – Advanced station settings]

Make detailed settings for the registered stations and control units. The settings can be made to a station or control unit individually, or multiple stations of the same type at a time. The setting items differ from the station or control unit type. First select a station (or stations) or control unit, and then open the “Advanced settings” window to make the settings.

Basic setting procedure

Click **Advanced station settings** in the table of contents.

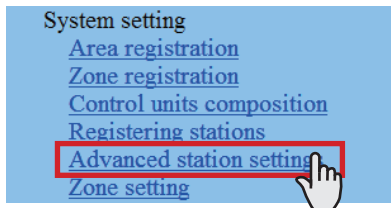

Click to check the station(s) or control unit where detailed settings are to be made.



- * Multiple stations of the same type can be set together. (Control units should be set respectively.)
- * All stations of the same type can be selected by clicking the corresponding button under [Select all by type].







Click **Advanced settings**.
The “Advanced settings” window for the selected station type or control unit opens.



Make the settings in the displayed windows.

For door and room sub stations 
 The right column of this page

For master stations 
 P.15

For control units 
 P.16



When you have finished making all the detailed settings:

Click **Temporarily stored** to save the current setting results temporarily.

- * If you wish to cancel the setting results you have made, click a title in the table of contents or “Refresh” in the web browser menu.

Making detailed settings to door stations or room sub stations



NOTE:

Make the settings to door stations or room sub stations respectively. You cannot select a video door station, audio door station and a room sub station at the same time.

The following setting item buttons are displayed in the “Advanced settings” window.

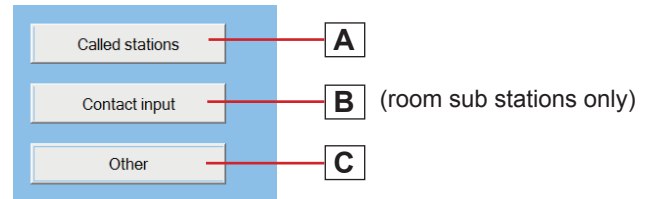

- * Click one of the buttons **A**, **B** and **C** to open the corresponding setting window, and then make the settings in the displayed window(s). See the detailed instructions for **A**, **B** or **C** below.

- * Click **Close** to close the current window and return to the previous window.

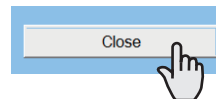

A Settings on [Called stations] setting window

Set the master station(s) that is (are) to be called from the selected station(s).

- * Up to 20 master stations can be set.

- 1 Select the “Call priority” from the pull-down menu.
- 2 Click **Reference** to open another window, then check the target master stations, and then click **Close** to return to the previous window.
The selected master stations are added and displayed in the list.

*Set up to 20 master stations.

	<input checked="" type="checkbox"/>	Area	Station number
1	<input type="checkbox"/>	01 1	001
2	<input type="checkbox"/>	01 1	002
3	<input type="checkbox"/>	01 1	003

- * To delete a station (or stations) from the list, check the target station(s) in the list and click **Delete**.

- 3 Repeat step 2 to add more master stations.
- 4 Click **Close** to close the current window and return to the previous window.

B Settings on [Contact input] window (for room sub stations only)

Make settings for contact input.

- **[Contact type]:**
Select either Normally open (NO) or Normally closed (NC).
- **[Call priority/Answering the page]:**
You can select the action of the station when detecting input between 'calling with appropriate priority' and 'answering the page'.
Select "Normal", "Priority", "Urgent" or "Answering the page".
- **[Close]**
Click this to close the current window and return to the previous window.

C Settings on [Other] window

- **[Transmit volume boost at PTT]:**
Select whether to increase the press-to-talk sound volume transmitted to the stations (ON) or not (OFF).
- **[Camera zoom image preset] (video door stations only):**
Select the default of camera's Zoom/Wide function at calling from the 9 zoom positions and "0" (wide) from the pull-down menu.
- **[Call acknowledge tone on/off]:**
Select whether to sound the call acknowledge tone of door station or room sub station (ON) or not (OFF).
- **[Backlight adjustment] (video door stations only):**
Select the method of adjusting the backlight in the daytime between "Exposure +" and "Exposure -".
- **[Speaker] (room sub stations only):**
Select the speaker to be used between "Built-in speaker" and "External speaker".
* When "External speaker" is selected, no sound will be output from the built-in speaker.
- **[Close]**
Click this to close the current window and return to the previous window.

About the priority

When receiving two or more functions (communication, calling, paging, monitoring, etc.) at the same time, depending on the priority setting, the order of priority for them is as follows.

Priority	Setting	Function
1 (high)	[Urgent]	Communication, calling, paging, chime paging
2	[Priority]	
3	[Normal]	
4 (low)	-	Monitoring, scan-monitoring

Making detailed settings to master stations



The following setting item buttons are displayed in the "Advanced settings" window.

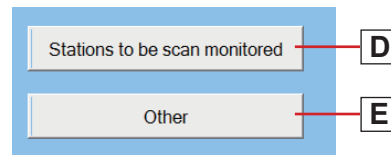

- * Click either the button **D** or **E** to open the corresponding setting window, and then make the settings in the displayed window(s). See the detailed instructions for **D** or **E** below.
- * Click **[Close]** to close the current window and return to the previous window.



D Settings on [Stations to be scan monitored] window

Set the scan-monitoring target sub station(s).

- * Up to 20 sub stations can be set.

- 1 Click **[Reference]** to open another window, then select the target stations, and then click **[Close]** to return to the previous window.
The selected stations are added and displayed in the list.
* To delete a station (or stations) from the list, check the target station(s) in the list and click **[Delete]**.
- 2 Repeat step 1 to register more stations.
- 3 Click **[Close]** to close the current window and return to the previous window.

E Settings on [Other] window

- **[Master station function: paging, chime, monitor, door release, and remote site call]:**

Select whether to enable the following functions of master station (ON) or not (OFF).

- Starting paging
- Starting chime paging
- Monitoring/scan-monitoring
- Releasing door
- Remote site call (standard (IP) system only)
- **[Close]**
Click this to close the current window and return to the previous window.

Making detailed settings to the central control unit, add-on control unit(s) or room sub control unit(s)



NOTE:

Make the settings to the central control unit, add-on control unit(s) or room sub control unit(s) respectively. You cannot select multiple control units at the same time.

The following setting item buttons are displayed in the “Advanced settings” window.

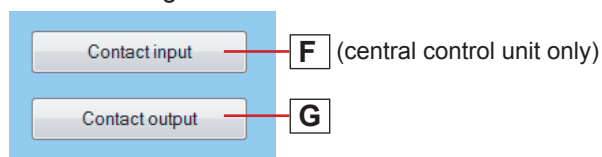

* Click either the button **F** or **G** to open the corresponding setting window, and then make the settings in the displayed window(s). See the detailed instructions for **F** or **G** below.

* Click **Close** to close the current window and return to the previous window.



F Settings on [Contact input] window (for central control unit only)

Set the input method to each of the CONTACT INPUT terminals.

1 Select the input terminal from S1 to S4 from the pull-down menu.



2 [Contact type]:
Select either Normally open (NO) or Normally closed (NC).

3 [Trigger condition]:
Select [None], [Broadcast chime] or [Stop chime] as the trigger condition. When an input is detected, the selected action is triggered.

- **[None]:**
None will be triggered if an input is detected.
- **[Broadcast chime]:**
Chime paging to the designated zone is triggered if an input is detected.
- **[Stop chime]:**
The currently-transmitted chime is stopped if an input is detected.

* Only when [Broadcast chime] is selected, the following items are valid.

- **[Sound source]:**
Select either [Internal sound source] or [External sound source] as the source of chime. When [Internal sound source] is selected, select a sound file or sequence from the registered ones in the list. (You need to register sound files and/or sound sequences in advance. (→P. 17-18))
When [External sound source] is selected, select either “External sound source 1” or “External sound source 2”.
- **[Chime priority]:**
Select the priority of chime paging from among “Normal”, “Priority” and “Urgent”.
- **[Zone name]:**
Select the target zone of chime paging from the registered ones in the list.

4 Repeat step 1 to 3 to make the settings to other terminals.

5 Click **Close** to close the current window and return to the previous window.

G Settings on [Contact output] window

Set the trigger condition to each of the CONTACT OUTPUT terminals.

1 Select an output terminal from the pull-down menu.



* Select from L1 to L8 for the central control unit, and select from L1 to L4 for the add-on control unit and room sub control unit.

2 [Contact type]:
Select either Normally open (NO) or Normally closed (NC).

3 [Trigger condition]:
Select the action as the trigger condition from among the following. When the selected action is detected, output is triggered.

- **[None]:**
No output will be triggered.
- **[Calling notice]:**
Set ON or OFF for “Normal”, “Priority” or “Urgent”.
- **[Door release]:**
Select one of the registered sub stations in the list to which an electric door strike is connected. (Click **Reference**, and then select the target station.)
- **[External sound source] (central control unit only):**
Select either “External sound source 1” or “External sound source 2” connected to the central control unit.
- **[PA output]:**
Select from among “PA output 1” to “PA output 4” connected to the control unit.

4 Repeat step 1 to 3 to make the settings to other terminals.

5 Click **Close** to close the current window and return to the previous window.

Registering stations and PA outputs to zones [System setting – Zone setting]

Assign stations and PA outputs to the registered zones.

- 1 Click **Zone setting** in the table of contents.

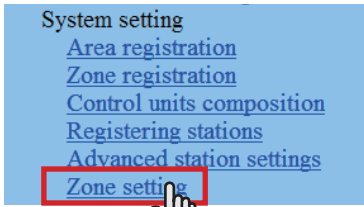

- 2 Select a zone from the pull-down menu.

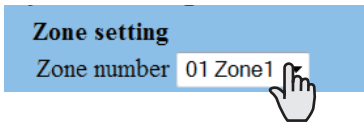

- 3 Click **Reference** to display all the stations registered to the system.

Another window opens and the registered stations are displayed in the list.

- 4 Check to select the target stations.

<input checked="" type="checkbox"/>	Area
<input checked="" type="checkbox"/>	Central control unit
<input checked="" type="checkbox"/>	D1 01 1
<input checked="" type="checkbox"/>	D2 01 1
<input checked="" type="checkbox"/>	D3 01 1
<input checked="" type="checkbox"/>	D4 01 1

Select stations in the following ways.

- Select stations by checking one by one.
- All stations of the same type can be selected by clicking the corresponding button under [Select all by type].
- By clicking the button for the control unit, all the stations connected to it are checked or canceled.
- By clicking the button on the top of the list, all the stations are checked or canceled.

- 5 Click **Close** after you have finished selecting the stations.

In the previous window, the selection results are displayed in the list.

* When canceling a registered station, check the station in the list, then click **Delete**.

* Register PA outputs in the same way as the stations.

- 6 Click **Temporarily stored** to save the current setting results temporarily.

* If you wish to cancel the setting results you have made, click a title in the table of contents or “Refresh” in the web browser menu.

Registering sound files for chime [Chime setting – Registering sound source]

Register sound data as the source of each chime. Copy MP3-format sound files onto the PC in advance. (Only MP3 files can be registered in the system.)

* Up to 3MB of the total amount of files can be registered.

* Use sound files compliant with the specifications below.

- 1 Click **Registering sound source** in the table of contents.

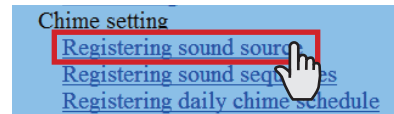

- 2 Click **Add**.

Another window opens.

- 3 Click **Browse...** and select a sound file on the PC.

- 4 Click **Upload** to save.

When uploading the file is completed successfully, the current window closes. In the previous window, the selection result is displayed in the list.

* If a small-size sound file is registered, a file size different from the actual one may be displayed.

- 5 Repeat step 2 to 4 to register more sound files.

* If you wish to delete a sound file, check it in the list, and then click **Delete**.

Sound file specifications

Item	Recommended value
File name	Up to 24 alphanumeric characters
File format	MP3* ¹
Bit rate	64 kbps
Sampling frequency	44.1 kHz
Channels	1 ch (monaural)
Maximum total data size	3MB in total, 2MB/file

*¹: MP3-format sound files with tags may not be played with this system. Before registering an MP3-format sound file, delete the tag from the file.

Registering sound sequences [Chime setting – Registering sound sequences]

Register sound sequences for chime.

* Up to 20 sequences can be registered.

- 1 Click **Registering sound sequences** in the table of contents.

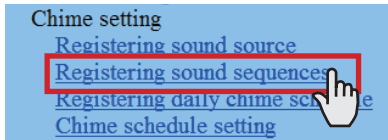

- 2 [Sound number]:
Select the sound number to register a sound sequence from the pull-down menu.
- 3 [Sound sequence name]:
Enter the name of sound sequence.
- 4 Click **Add** to add sound files to the sound sequence.
Another window appears.
- 5 [Step]:
Select an unused step number from the pull-down menu.
 - * If the selected step number is already used, it can be set with a new sound source and the old and subsequent ones are renumbered with the following numbers.
 - * If an unused number exists before the number you selected, the unused number is re-selected automatically.
 - * Up to 10 steps can be used.
- 6 [Sound source]:
Select a sound file from the registered ones and set the repeating time (from 1 to 10) of the sound.
- 7 When you have finished the setting on this window, click **Close**.
In the previous window, the registered sound files are displayed in the list.
- 8 Repeat step 2 to 7 to register more sound sequences.

Other buttons

- **Edit**
If you wish to modify, check the file in the list, and then click **Edit**.
 - **Delete**
When deleting an added sound file, check the file in the list, and then click **Delete**.
- 9 Click **Temporarily stored** to save the current setting results temporarily.
 - * If you wish to cancel the setting results you have made, click a title in the table of contents or "Refresh" in the web browser menu.

Registering daily chime schedule [Chime setting – Registering daily chime schedule]

Up to 10 daily schedules can be registered.

- 1 Click **Registering daily chime schedule** in the table of contents.

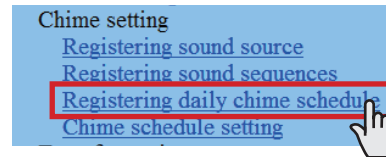

- 2 [Schedule number]:
Select the schedule number to register the daily schedule from the pull-down menu.
- 3 [Schedule name]:
Enter the name of daily schedule.
- 4 Click **Add** to add programs.
Another window appears.
- 5 [Chime time]:
Set the starting time (hour, minute and second).
- 6 [Sound source]:
Check [Sound file], [Sound sequence] or [External sound source], and select a file, sequence or external sound source from the pull-down menu.
- 7 [Zone number]:
Select the target zone for transmitting chime from the pull-down menu.
- 8 [Chime priority]:
Select the priority of transmitting chime from among "Normal", "Priority" or "Urgent" from the pull-down menu.
- 9 When you have finished the settings on this screen, click **Close**.
In the previous window, the added program is displayed in the list.
- 10 Repeat step 4 to 9 to add more programs.

Other buttons

- **Edit**
If you wish to modify a program, check the program in the list, and then click **Edit**.
 - **Delete**
When deleting a program, check the program in the list, and then click **Delete**.
- 11 Click **Temporarily stored** to save the current setting results temporarily.
 - * If you wish to cancel the setting results you have made, click a title in the table of contents or "Refresh" in the web browser menu.

Setting chime schedule [Chime setting – Chime schedule setting]

You can set a weekly chime schedule or individual daily schedule.

* The settings can be made to 1 year ahead.

- 1 Click **Chime schedule setting** in the table of contents.
- 2 Make the settings by clicking **Weekly schedule**, **Individual schedule** and **Schedule download** respectively to open the corresponding window.

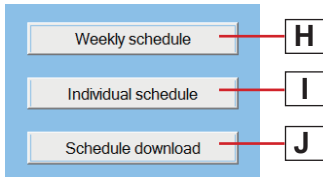

* **Individual schedule** should be clicked after the target date is clicked on the calendar.

- 3 Make the settings in the displayed window(s).



See the detailed instructions for **H**, **I** or **J** on the right column of this page.

- 4 After the setting is finished on the corresponding window, click **Close** to close the window.

Calendar and setting status can be checked for the selected month.

The registered daily chime schedules are identified by colors and shown on the calendar.

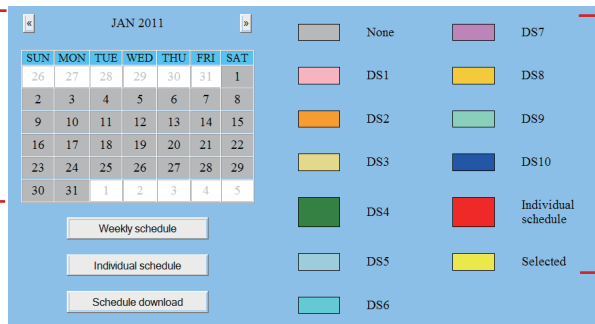

- 5 Click **Temporarily stored** to save the current setting results temporarily.

* If you wish to cancel the setting results you have made, click a title in the table of contents or “Refresh” in the web browser menu.

- 6 When the settings on this window have finished, update the system from **[Updating the system]**. (→P. 22)

H Settings on [Weekly schedule] setting window

- 1) Select either [Every week] or [Every other week].
- 2) Set the schedule start and end dates.
 - * The monthly calendar is displayed by clicking **Refer calendar** and you can select the start and end dates.
 - * If necessary, you can change the month by clicking **«** or **»**.



- 3) Set one of the registered daily chime schedules or no schedule to each day of the week. (Select one from the pull-down menu.)

I Settings on [Individual schedule] setting window

Set an individual schedule to the target date.

* [Individual schedule] setting window will not open if you have not selected the target date on the calendar in the [Chime schedule setting] window.

- 1) If necessary, you can change the date by clicking **«** or **»** repeatedly.
- 2) [Daily chime schedule]:
Select one of the registered daily chime schedules or no schedule (to register a new schedule), from the pull-down menu.
- 3) If necessary, modify a registered schedule or register a new schedule.

• To register a new schedule:

Click **Add**.

Another window opens. In this window, you can set [Chime time], [Sound source], [Zone number] and [Chime priority].

When the settings have finished, click **Close** to close this window. In the previous window, the added program is displayed in the list.

* Repeat this procedure to add more programs.

• To modify a registered schedule:

Check the program you wish to modify, and then click **Edit**. Another window opens. Change the settings in this window.

When finished modifying, click **Close** to close this window.

* You can also modify the registered schedule by adding new program(s) or deleting program(s). (To delete, check the target program(s) in the list and then click **Delete**.)

* When modified, [Daily chime schedule] changes to “Individual schedule.”

• To delete a registered schedule:

Select “None” from the pull-down menu of [Daily chime schedule].

J Downloading chime schedule data

You can store the chime schedule setting data in CSV format onto a PC.

* The data includes the transfer schedule setting (→P. 20) data along with the chime schedule setting data.

Registering daily transfer schedule [Transfer setting – Registering daily transfer schedule]

You can set the schedule for transferring calls to other master stations automatically. The schedules registered on this setting are used when making a transfer setting on a master station.

Up to 2 daily schedules can be registered.

- 1 Click **Registering daily transfer schedule** in the table of contents.

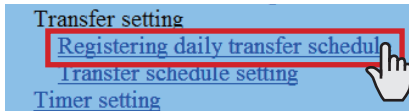

- 2 [Schedule number]:
Select the schedule number DT1 or DT2 from the pull-down menu.
- 3 [Schedule name]:
Enter the name of daily schedule.
- 4 [Call transfer time]:
Set the [Start time (hour and minute)] and [End time (hour and minute)] of transferring.
- 5 Click **Temporarily stored** to save the current setting results temporarily.
 - * If you wish to cancel the setting results you have made, click a title in the table of contents or "Refresh" in the web browser menu.

Setting transfer schedule [Transfer setting – Transfer schedule setting]

You can set a weekly transfer schedule and individual daily schedule.

* The settings can be made 1 year ahead.

- 1 Click **Transfer schedule setting** in the table of contents.
- 2 Make the settings by clicking **Weekly schedule** and **Individual schedule** respectively to open the corresponding window.

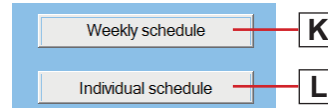

* **Individual schedule** should be clicked after the target date is clicked on the calendar.

- 3 Make the settings in the displayed window(s).



See the detailed instructions for **K** or **L** on the next page.

- 4 After the setting is finished on the corresponding window, click **Close** to close the window.

Calendar and setting status can be checked for the selected month.

The registered daily transfer schedules are identified by colors and shown on the calendar.

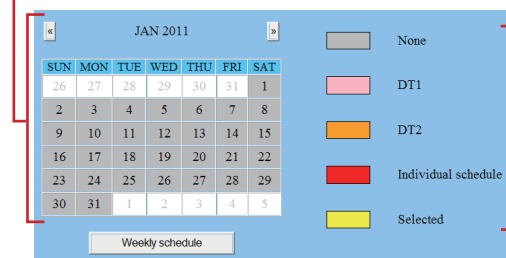

- 5 Click **Temporarily stored** to save the current setting results temporarily.
 - * If you wish to cancel the setting results you have made, click a title in the table of contents or "Refresh" in the web browser menu.
- 6 When the settings on this window have finished, update the system from **Updating the system**. (→P. 22)

K Settings on [Weekly schedule] setting window

- 1) Select either [Every week] or [Every other week].
- 2) Set the schedule start and end dates.
 - * The monthly calendar is displayed by clicking **Refer calendar** and you can select the start and end dates.
 - * If necessary, you can change the month by clicking **◀** or **▶**.
- 3) Set one of the registered daily transfer schedules or no schedule to each day of the week. (Select one from the pull-down menu.)

L Settings on [Individual schedule] setting window

Set an individual schedule to the target date.

* [Individual schedule] setting window will not open if you have not selected the target date on the calendar in the [Transfer schedule setting] window.

- 1) If necessary, you can change the date by clicking **◀** or **▶** repeatedly.
 - 2) [Daily transfer schedule]:
Select either of the registered daily schedules (DT1 or DT2) or no schedule from the pull-down menu.
 - 3) [Call transfer time]:
 - When “DT1” or “DT2” is selected:
The call transfer time is automatically entered.
If necessary, change the [Start time (hour and minute)] and [End time (hour and minute)] of transferring manually.
 - When no schedule is selected:
Enter the call transfer time manually.
- * When the time is entered or changed manually, [Daily transfer schedule] changes to “Individual schedule”.

Setting the timer [Timer setting]

Set the time for each operation.

- 1 Click **Timer setting** in the table of contents.

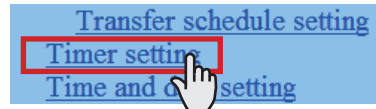

- 2 Set the time for the following operations respectively.

* The setting range is displayed on the right side of each input box.

- **[Call]:**
Set the duration of call from door stations and room sub stations to [Normal], [Priority] or [Urgent].
- **[Communication In Local]:**
Set the duration of communication between stations.
- **[Paging]:**
Set the duration of paging.
- **[Monitor]:**
Set the duration of monitoring only one station.
- **[Scan monitor: Switching]:**
Set the duration of monitoring each station while scan-monitoring.
- **[Contact output]:**
Set the duration of chime from the external sound source 1 and 2, triggered by contact output of the central control unit (IS-CCU).
- **[Door release]:**
Set the duration of door release.
 - * If you set the time to “0”, the door is released while the door release button on the master station is held down.

- 3 Click **Temporarily stored** to save the current setting results temporarily.

* If you wish to cancel the setting results you have made, click a title in the table of contents or “Refresh” in the web browser menu.

Setting time and date [Time and date setting]

Set the time and date of the system, used for chime schedule and transfer schedule.

- 1 Click **Time and date setting** in the table of contents.

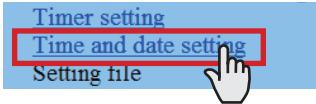

- 2 Set the following settings.

- **[Set current time] Required:**

Set the current time and date in one of the following methods.

- Input the current time and date manually, and then click **Manual setting**.
- Click **Synchronized with PC** to set the current time and date by making it synchronized with the PC.
- You can also set the current time and date by making it synchronized with NTP server [**Synchronized with NTP server**] as shown below.

* If there is no power supply to the system for a long time because of power failure etc., the time and date setting may be cleared.

- **[NTP (Network Time Protocol)]:**

Set [**Synchronized with NTP server**] to ON to set the current time and date by making it synchronized with NTP server. Then set the [**NTP server**] and [**NTP port number**].

* **[NTP server]:**
Enter the IP address or domain name of the NTP server to be used as the master clock.

- **[UTC time zone]:**

Set the time differences from Coordinated Universal Time (UTC). Set the [**Hour difference**] and [**Minute difference**] respectively.

- **[Synchronize interval]:**

Set the time data acquisition interval (hour) from the NTP server, and the interval of synchronization with the system.

- **[Daylight savings time]:**

Set whether to utilize daylight savings time (ON) or (OFF). When set to ON, then set the start and end times (Month, Week of the month, Day of the week, Hour and Minute), and time differences (Hour and Minute).

* It is recommended to connect the system with a PC or NTP server constantly to keep the correct time and date setting.

- 3 Click **Temporarily stored** to save the current setting results temporarily.

* If you wish to cancel the setting results you have made, click a title in the table of contents or "Refresh" in the web browser menu.

Downloading/uploading setting data [Setting file]

You can download the setting data you have made into a file and save it on the PC. On the contrary, you can upload the setting data from the PC.

* It is recommended to download the setting data as a backup copy after you finish making settings or setting changes.

■ When downloading setting data onto the PC

- 1 Click **Downloading setting data** in the table of contents.

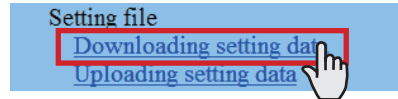

- 2 Click **Download** to download the current setting data into a file.

NOTE:

MP3-format sound files registered at [**Chime setting – Registering sound source**] will not be downloaded from the system by this operation.

It is recommended that you also save the registered MP3 files separately.

■ When uploading setting data

- 1 Click **Uploading setting data** in the table of contents.

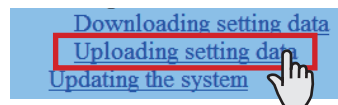

- 2 Click **Upload** to upload the setting data from the PC to the system.

You can select the setting data file from another window, and upload it.

- 3 Update the system.

* Refer to "Updating the system" below.

NOTE:

Uploading the setting data will overwrite the current data.

* Upload sound files separately to register them as the internal sound sources.

Updating the system [Updating the system]

Update the system with the setting data you have entered (currently stored temporarily).

- 1 Click **Updating the system** in the table of contents.

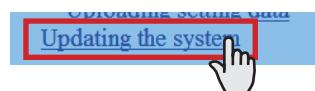

- 2 Click **Update** to update the system with the setting data currently stored temporarily.

NOTE:

Do not turn off the system while updating the system.

MAINTENANCE

This section describes the use of functions for the system maintenance. These functions are available on the web server.

Initializing the system [Initialization]

You can reset the system settings to factory default.

- 1 Access the web browser and log in.
(→P. 9)
- 2 Click **Initialization** in the table of contents.



- 3 Click .

Downloading system log [System log]

You can acquire the system operation log.

- 1 Access the web browser and log in.
(→P. 9)
- 2 Click **System log** in the table of contents.



- 3 Click to acquire the log from the system.
- 4 Confirm the log, and save it as needed.

NOTE:

The log is overwritten constantly from the oldest records.

Updating the firmware [Firmware update]

■ Downloading updated firmware data

Please access our web page at <http://www.aiphone.net/> and download the firmware data on the PC to update the system. For the download procedure, see the instructions on our web page.

- 1 Access the web browser and log in. (→P. 9)
- 2 Click **Firmware update** in the table of contents.

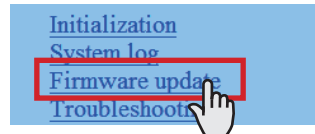

- 3 Click .
 - Another window opens.
 - 4 Click and select the target firmware.
 - 5 When the firmware is displayed in the window, click .
- When "Update firmware." is displayed, the update process is complete.

NOTES:

- If the power is turned off while it is writing, the product will malfunction.
- The system may not operate normally while updating the firmware.

NOTE:

If the update fails, try again.

Referring to the troubleshooting guide [Troubleshooting]

- 1 Click **Troubleshooting**.

The following information appears in the window.

- Information about the online-help that you can refer to when trouble occurs in setting the system.
- Supported characters and symbols

Registering your system [Registration]

- 1 Click **Registration** in the table of contents.
- 2 Click to open the registration window, and then register your system on the window.

NOTE:

The central control unit (IS-CCU) must be connected to the IP network to register your system.



AIPHONE®

Providing Peace of Mind

<http://www.aiphone.net/>

AIPHONE CO., LTD., NAGOYA, JAPAN
AIPHONE CORPORATION, BELLEVUE, WA, USA
AIPHONE S.A.S., LISSES-EVRY, FRANCE