

## VIDEO SENTRY COLOR TILT AUDIO VIDEO ENTRY SECURITY INTERCOM

Models: **KC-1GRD**, *Main monitor station*  
**KC-1HRD**, *Sub monitor station*

### INSTALLATION MANUAL

**!** For installation of the KC-1SD and PS-24E, please refer to the respective Installation Manual for details. Check the package contents before installation.

#### KC-DAR

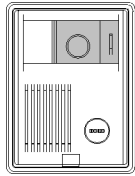

##### Package Contents

Screws (2)  
Wood Screws (2)  
Hexagonal wrench

Please save Hexagonal wrench for maintenance.

#### KC-1GRD

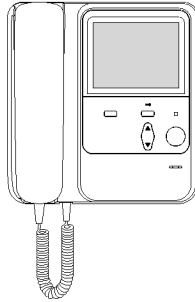

##### Package Contents

Installation Manual  
Operation Manual  
Screws (4)  
Wood Screws (4)  
Connector (for door release)

#### KC-1HRD

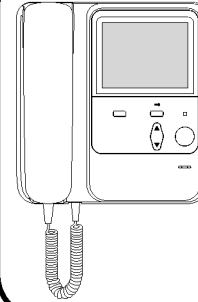

##### Package Contents

Installation Manual  
Operation Manual  
Screws (4)  
Wood Screws (4)

## **⚠ PRECAUTIONS ON INSTALLATION & WIRING**

This manual and the markings on the product contain various symbols in order that the product will be used safely and properly, and that the installer and user are protected from injury and property damage. The following precautions must be thoroughly read and understood before proceeding.

**⚠ WARNING** Negligence could result in death or serious injury.

**⚠ CAUTION** Negligence could result in injury or damage to property.

### Explanations of Symbols;



#### GENERAL PRECAUTIONS

The **⚠** mark indicates caution statement (incl. danger and warning), which is specifically shown inside.



#### GENERAL INSTRUCTIONS

The **!** mark indicates contents which demand a specific action shown inside or attached.



#### GENERAL PROHIBITIONS

The **⊘** mark indicates contents which prohibit a specific action shown inside or attached.



#### DISMANTLING PROHIBITIONS



#### MOISTURE PROHIBITIONS

### **⚠ WARNING**

1. Inside the KC-1GRD/1HRD monitor station, high voltage is present. Do not open KC-1GRD/1HRD case, as electric shock could result. **⊘**
2. Do not change or alter KC-1GRD/1HRD. It can cause fire or electric shock. **⊘**
3. Keep KC-1GRD/1HRD away from water or any other liquid. Fire or electric shock could result. **⊘**
4. Do not put any metal through openings of KC-1GRD/1HRD. It can cause fire, electric shock or unit damage. **⊘**
5. Keep AC cord of power supply from being marred or crushed. If damaged, fire or electric shock could result. **⊘**
6. Do not plug or unplug with wet hands. Electric shock could result. **⊘**
7. Keep AC plug away from moisture or dust. Fire could result. **!**
8. Do not use any power source other than specified. Fire or electric shock could result. **⊘**
9. Do not put any forcible strength on the video monitor. Damage may result. **⊘**
10. Make sure wires are connected properly before plugging in power supply. **⊘**

### **⚠ CAUTION**

1. Do not install or make any wire terminations while power supply is plugged in. It can cause electrical shock or damage to the unit. **!**
2. Verify chime volume while handset is on the hook. Chime sound from KC-1GRD/1HRD speaker is loud, and may cause hearing damage. **!**
3. Mount KC-1GRD/1HRD on wall in a convenient location, but not where it could be bumped or jarred.
4. In case of electrical storms, unplug power supply from AC outlet. It can cause fire, electric shock, or unit damage. **!**
5. Do not install KC-1GRD/1HRD in any of the following locations, as it can cause fire, electric shock or unit damage: **⊘**
  - High or extreme cold temperature area, under direct sunlight, near equipment that varies in temperature, in front of air conditioner, inside a refrigerated area, etc.
  - Places subject to moisture or humidity extremes (bathroom, cellar, greenhouse, etc.) **⊘**
  - Places subject to environmental conditions, such as oil, dust, chemicals, salt, etc.
  - Places subject to constant vibration or impact.
  - Where noise generating devices such as TV or radio are close by.
  - Places subject to steam or smoke. (near heating equipment or cooking surfaces)

### **⚠ GENERAL PRECAUTIONS**

1. KC-1GRD equipment, except for KC-DAR, is designed for indoor use only. Do not install outdoors.
2. KC-1GRD system is not operational during a power failure.
3. In areas where broadcasting station antennas are close by, intercom system may be affected by radio frequency interference.
4. Keep all DC wiring at least 1', (30cm) away from AC 100-240V wiring, fluorescent lighting, or dimmer switches. Otherwise, cross AC wiring at a 90°.
5. KC-1GRD system must be installed at least 3'3", (1m) away from TV or radio.

Max. wiring distance w/1.0mm dia. 18AWG cable

Two Sub monitors w/two PS-24E  
Homerun power wires to each monitor.

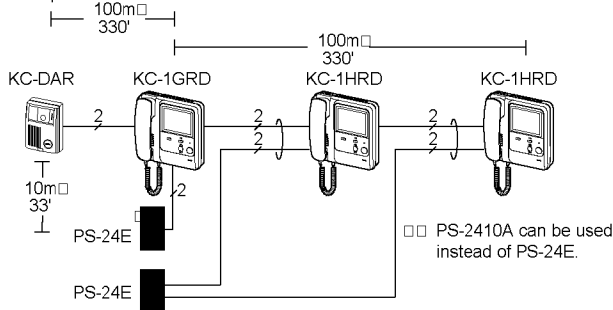

Two Sub monitors w/one PS-24E

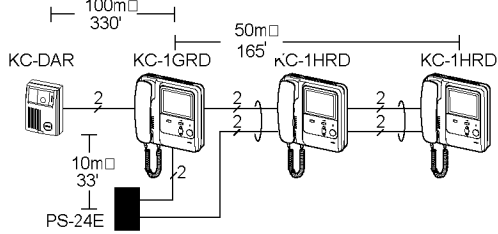

## MOUNTING

### Main/Sub monitor station

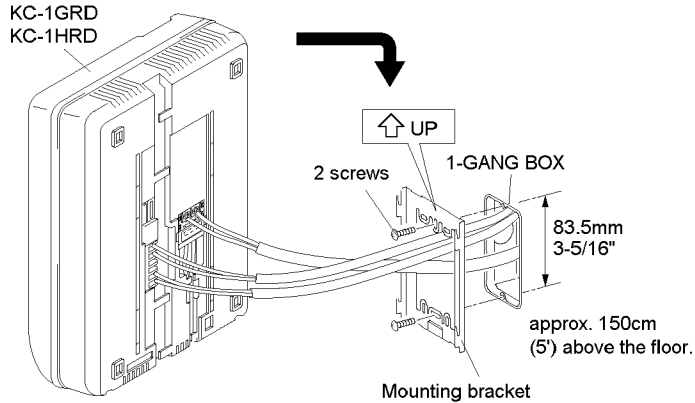

### Video door station

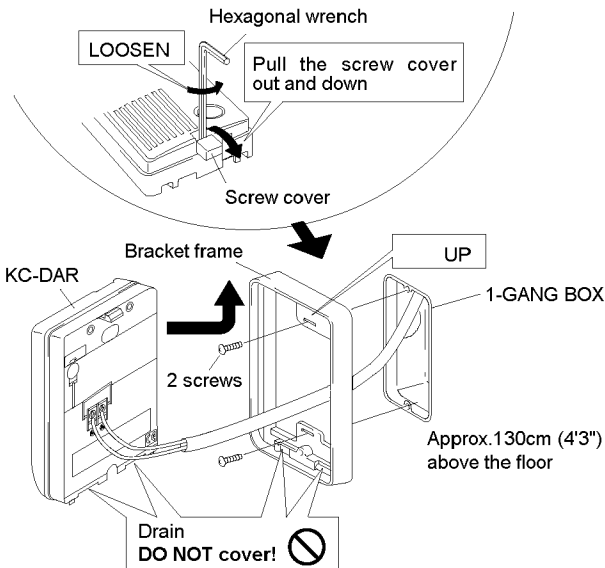

## Wiring Precautions

- Keep all DC wiring at least 30cm, 20" away from AC 100~240V wiring, fluorescent lighting, or dimmer switches. It may cause noise interference or malfunction.
- Use a parallel conductor cable. Coaxial cable should not be used.

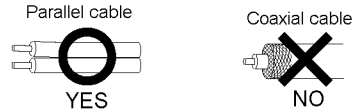

Vinyl jacketed, PE (polyethylene) insulation cable is recommended.

- Extra pair(s) in the installed cable can affect image quality, and must be terminated with a 120 ohm resistor at each end.

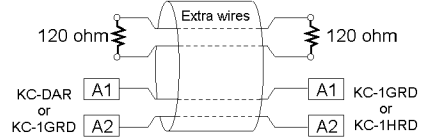

Main & sub monitor stations must be wired in a daisy-chained fashion, never homerun.

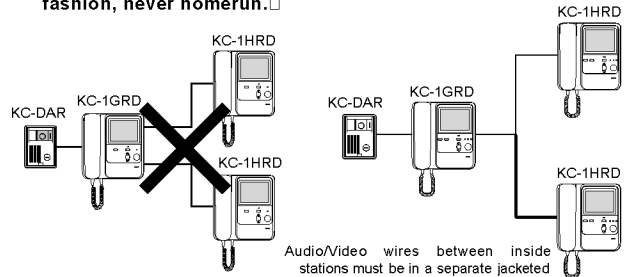

KC-1SD: Wiring is the same as sub monitor station.

- If proper cable is not used, system may malfunction.

## Mounting Precautions

- The video door station employs a CCD camera, and its performance may be affected by bright direct light, such as strong sunlight, gate light or street or porch light which is directed into the camera lens. Install the video door station in front of the visitor's position.
- When outside temperature lowers sharply, after rain, etc., the inside of the camera may fog up slightly, causing a blurry picture, but this is not a malfunction. Normal operation will be restored when moisture evaporates.

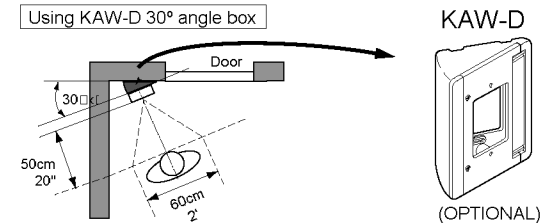
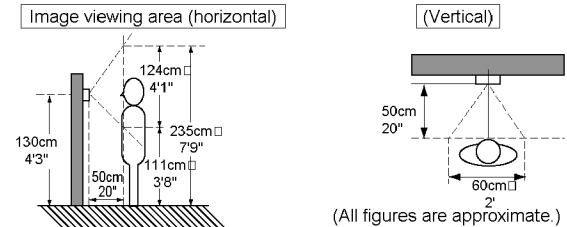

**NOTE** See KC-1SD Installation Manual for details.

**!** Do not use extra terminals for other purposes.

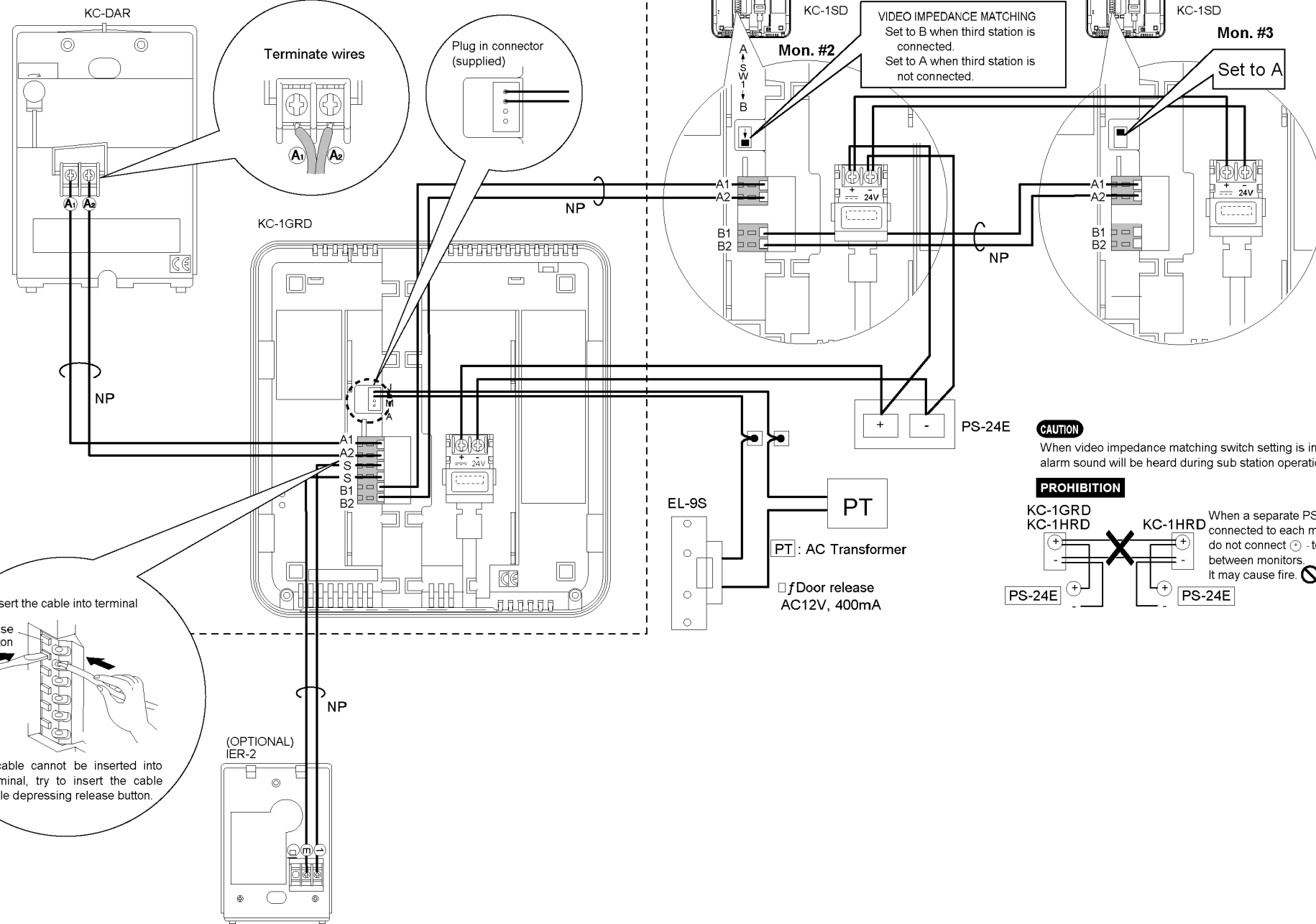

Terminate wires

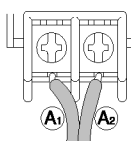

Plug in connector (supplied)

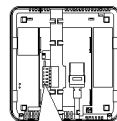
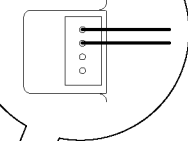

KC-1HRD or KC-1SD

Mon. #2

**VIDEO IMPEDANCE MATCHING**  
Set to B when third station is connected.  
Set to A when third station is not connected.

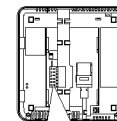

KC-1HRD or KC-1SD

Mon. #3

Set to A

- 3 -

Insert the cable into terminal

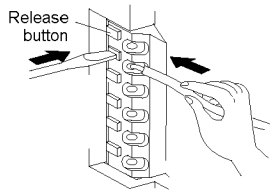

If cable cannot be inserted into terminal, try to insert the cable while depressing release button.

(OPTIONAL) IER-2

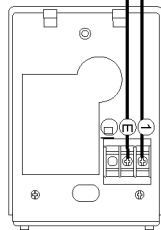

**CAUTION**

When video impedance matching switch setting is incorrect, alarm sound will be heard during sub station operation.

**PROHIBITION**

KC-1GRD  
KC-1HRD

KC-1HRD

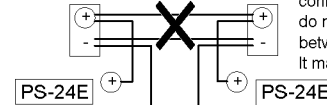

When a separate PS-24E is connected to each monitor, do not connect  $\ominus$  - terminals between monitors. It may cause fire.  $\ominus$

# BEFORE ASKING FOR REPAIRS

Trouble	Potential cause of trouble	Solution
<input type="checkbox"/> The system does not have chime tone when call button is pressed. <input type="checkbox"/> Cannot communicate with door station. <input type="checkbox"/> Image does not appear when the monitor button is pressed.	<input checked="" type="checkbox"/> Check the power supply.	<input type="checkbox"/> Turn on the Power switch.
	<input checked="" type="checkbox"/> Make sure the system is being powered correctly.	<input checked="" type="checkbox"/> Check the power supply voltage.
	<input type="checkbox"/> Check the wiring between the door station and master station.	<input type="checkbox"/> Check if the cable is connected to the right terminals. (A1 to A1, A2 to A2)
<input type="checkbox"/> Hard to hear the call tone from door station.	<input type="checkbox"/> In some cases, environmental noise around the master station make the chime hard to hear.	Adjust tone volume.
<input type="checkbox"/> Can hear outside voice even though handset is not lifted.	<input type="checkbox"/> It is a normal operation. The system has a feature to monitor outside instantly when the call is pressed.	<input type="checkbox"/> Adjust monitor volume. Add chime extension speaker (IER-2) if necessary.
<input type="checkbox"/> The LCD monitor looks too dark or too bright.	<input type="checkbox"/> It is normal operation because of characteristics of LCD panel.	<input checked="" type="checkbox"/> Adjust Bright control.
<input type="checkbox"/> Hard to see the monitor when it gets dark outside. <input type="checkbox"/> White light sometimes turns on at the door station.	<input type="checkbox"/> Appropriate lighting conditions are needed for a clear picture. <input type="checkbox"/> LED illuminators turn on automatically when it gets dark outside.	<input checked="" type="checkbox"/> Adjust the White Light illuminator to <input type="checkbox"/> OFF or ON as needed.
<p>KC-1GRD BOTTOM VIEW</p>		
<input type="checkbox"/> There is a white dot or a portion steadily lit on the monitor.	<input type="checkbox"/> It must be noted in advance that the TFT Color LCD panel, though manufactured with very high precision techniques, inevitably has a very small portion of picture elements that are either steadily lit or not lit at all, which is not considered a unit malfunction.	

# SPECIFICATIONS

## KC-1GRD/1HRD (Main/Sub monitor station)

Power source	DC24V
Current	KC-1GRD Max. 700mA, 70mA standby KC-1HRD Max. 500mA, 50mA standby
Call tone	From video door station 4-Tone chime Call-in LED blinks Master station → Sub master station <input type="checkbox"/> Electronic pre-tone and voice from the other station. All call button blinks.
Wiring Distance	KC-1GRD to the farthest KC-1HRD KC-1GRD to IER-2 Chime extension KC-DAR to KC-1GRD <div style="border: 1px solid black; padding: 2px; display: inline-block;">           18AWG 330', 1.0 mm 100m            22AWG 165', 0.65mm 50m         </div>
Communication	Simultaneous via handset
Video monitor	4" TFT color LCD
Ambient temperature	32°F -104°F (0° - 40°C)
Housing	Fire-retardant ABS plastic
Color	White
Dimensions	(H x W x D) 7-3/4" x 7-1/4" x 3-1/2", 195mm x 185mm x 88mm
Weight	2.2lbs. (1kg) approx.
Door release	AC12V, 400mA

## KC-DAR (Video door station)

Power source	DC12V in standby. DC22V in operation (supplied from KC-1GRD)
Current	4mA approx. in standby, 350mA approx. max.
Picture element	1/4" color CCD
Image viewing area	Approx. 2' Horiz., 3'8"-7'9" Vert. at 4'3" high (up to box center) and 20" away from camera. (60cm H, 111~235cm V at 130cm high & 50cm away)
Lighting at night	White LED illuminators cast up to 1' (30cm), in front of camera. <input type="checkbox"/> Background scene beyond cannot be seen.
Communication	Hands free
Ambient temperature	14°F~140°F(10°C~60°C)
Housing	Fire-retardant ABS plastic.
Color	Gray
Dimensions	(H x W x D) 5-1/2" x 4-1/8" x 1-3/4", 140mm x 105mm x 44mm
Weight	0.68 lbs. (310g) approx.