

LOUDSPEAKER INTERCOM SYSTEM

MODEL LAF-10S (10-call master with All Call and door release button)

— INSTRUCTIONS —

LAF-10S CAN BE INTERMIXED WITH LAF-3A/A, LAF-5, LAF-10, LAF-10B/A AND SUBSTATIONS.

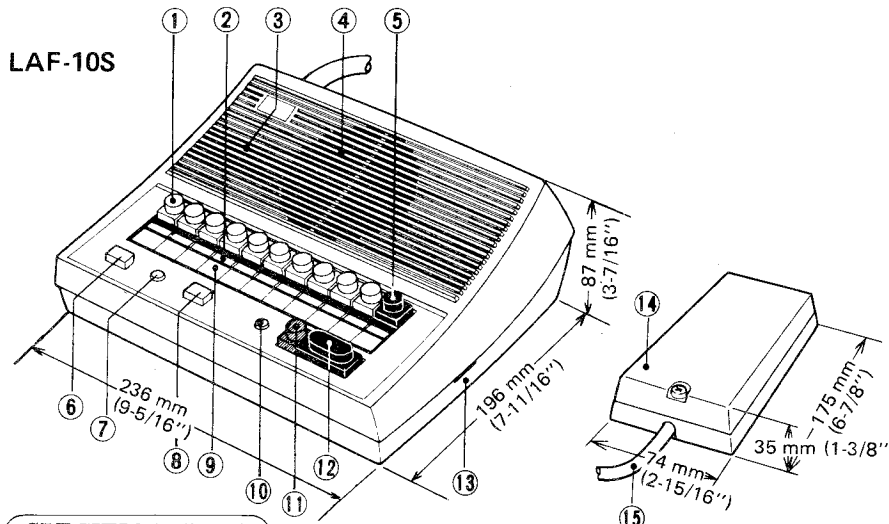

NAMES AND FUNCTIONS

- ① Station selector button
- ② Call-in annunciator light
- ③ Microphone
- ④ Speaker
- ⑤ OFF button
- ⑥ ALL CALL button
- ⑦ ALL Call output indicator light
- ⑧ Door release button
- ⑨ Directory card
- ⑩ Occupied light
- ⑪ Privacy button
- ⑫ TALK button
- ⑬ Volume control (for communication)
- ⑭ Terminal box
- ⑮ Terminal cord

SPECIFICATIONS

- * Power source: DC 12V. Use PS-12A or PS-12S (PS-12C in North America) power supply.
- * Current consumption: 350 mA maximum per station.
- * Power output: 800 mW maximum at 20 ohm.
- * Communication: Push button station selection. Press-to-talk operation at calling master. Occupied light illuminates when the system is in use.
- * Calling: From master to master (or sub) by voice or electronic tone.
From sub to master by electronic tone and timed LED annunciation for about 20 seconds.
- * Switching contact capacity for door release: AC 240V, 1A; DC 30V, 1A.
- * Wiring: In all-master system; 4 common plus 1 individual wire per station between masters.
In one-master system; 2 individual wires per sub.
In intermixed system; 4 common plus 1 individual wire per station between masters.
2 common plus 1 individual wire per sub.

	Between masters	Between masters & BG-1A/BG-1B
For communication	4 common + 1 individual	
For BGM	4 common + 1 individual	4 common + 1 individual
For All Call	7 common + 1 individual	7 common + 1 individual
For both BGM and All Call	7 common + 1 individual	7 common + 1 individual
For door release	Additional 2 common	—

FEATURES

- * Background music and all call can be included, using BG-1A/BG-1B and PG-10A/PG-10B.
- * Includes a button for door release.
- * Straight paging is available through a 8 ohm horn speaker, using PG-3.
- * Handsfree reply and high output power allow use in large or noisy rooms.
- * Single talk path.
- * Individual volume controls for communication and call tone on master.
- * Timed call-in annunciator light memory for about 20 seconds.
- * Five different sub stations.
- * Privacy button on master prevents eavesdropping.
- * Desk or wall mount (Desk top use only with LAR-2 handset).
- * Optional handset for private communication (for field installation only).

COMPONENTS AVAILABLE FOR USE WITH YOUR LAF-10S SYSTEM

*** Master Stations;**



LAF-10S: 10-call master. Includes buttons for door release and all call.

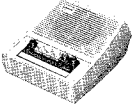

LAF-3A (Type A): 3-call master.



LAF-5: 5-call master.



LAF-10: 10-call master.



LAF-10B (Type A): 10-call master. Includes buttons for door release and all call. Flush mount.

*** Accessories;**



BG-1A: BGM & ALL Call adaptor. Use with PG-10A (for N. America only).
BG-1B: — do —, Use with PG-10B.



PG-10A: UL & CSA LISTED BGM/All Cal amplifier, 10W (for N. America only).
PG-10B: Standard paging amplifier, 10W.

*** Power supply;**



PS-12C: UL & CSA LISTED Power supply. (for N. America only).
PS-12A: Standard power supply.

*** Sub stations:**

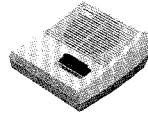

LA-A: Standard sub.

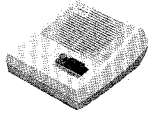

LA-AN: Privacy type sub.



LA-D: Weather-resistant door station.



LA-A3: 3-call sub.

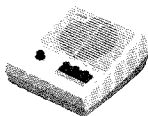

LA-AN3: 3-call privacy type sub.



LA-DA: Flush-mount door station.



LT-1: 20-to-8 ohm matching transformer. Connects LAF master to a 8 ohm paging horn.



LAR-2: Optional handset for LAF-5, LAF-10 & LAF-10S. Field installation only.

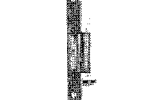

PG-3: 3-watt paging amplifier.

EL-9S: Electric door release.

INSTALLATION

Do not attempt to install your LAF-10S system until you have read and thoroughly understand the installation procedure. The Aiphone warranty is void if the system is installed in a manner other than described in this manual.

ACTUAL TERMINAL LOCATIONS

* Terminal identification label is put on back of the terminal box cover.

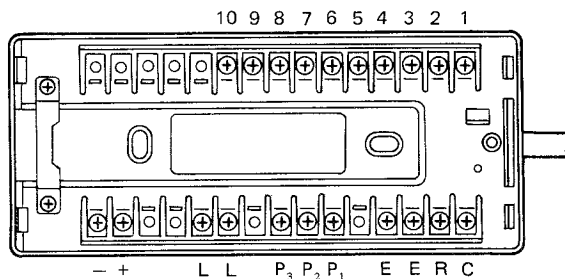

- 1 — 10 : for connecting to relative stations.
- C : for receiving a call and BGM.
- + , - : for power supply.
- E : for common communication.
- R : for occupied lamp.
- L , L : for connecting door release.
- P₁ : for All Call control.
- P₂ , P₃ : for All Call output.

WIRING

Lay out your system in advance. Determine the exact location of each station. Make a sketch showing the number of wires required from each station to other stations. Assign station numbers at this time.

Begin your installation with master station #1. All masters included in your system should be connected and tested before beginning sub station installation. A space is provided at the left of the diagram to write in your color code. Note the position of C terminal on each master station. Be sure you wire each station correctly.

After installing your second station we recommend the power supply be connected to plus and minus and a test be made for all functions calling and talking between each station. Unplug power supply while making connections.

Refer to the chart below and select the proper wire gauge to meet your requirements.

AWG WIRE SIZE	24 AWG	22 AWG	20 AWG	18 AWG
DISTANCE	400'	650'	1000'	1600'
DIAMETER OF WIRE	0.5 mm	0.65 mm	0.8 mm	1.0 mm
DISTANCE	120 m	200 m	300 m	480 m

WALL MOUNTING INSTALLATION

- 1) Attach mounting bracket to wall or box with supplied screws.
- 2) Mount station upon the mounting bracket.

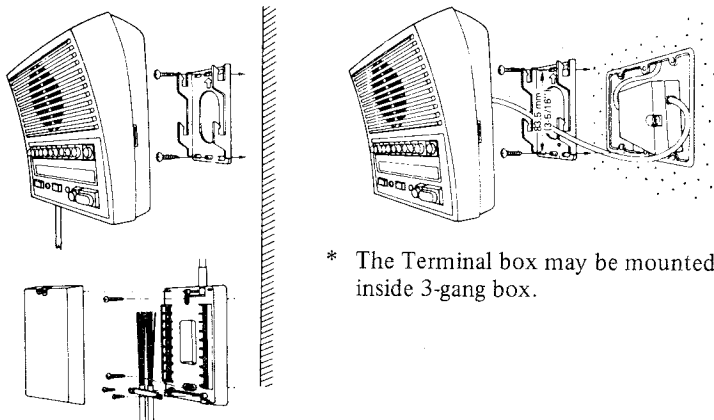

INSTALLATION OF TERMINAL BOX

- 1) Remove screw and cover as shown.
- 2) Attach bottom case to wall or box.
- 3) Wire terminal plate and replace cover.

LA-D INSTALLATION

- (1) Attach the unit to single gang box with the supplied 2 screws.
- (2) When mounting to wall, conductors may be pulled out either from top or bottom of the back case.

As shown, remove the outlet part of the case when passing conductors through the top.

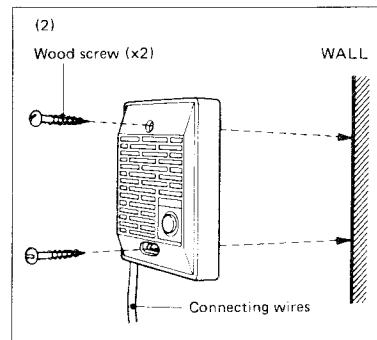
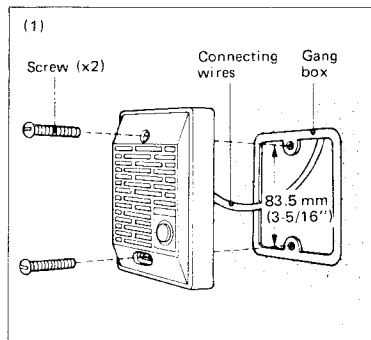
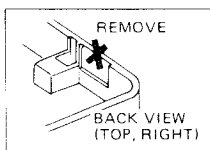

INSTALLATION OF LAR-2 OPTIONAL HANDSET

- 1) Remove four screws on the bottom of master station LAF-10S and lift the plastic case from the base.
- 2) Using a diagonal cutter, cut off 3 jumper wires on the printed circuit board.
- 3) Using 8 mm (1/4'') drill or soldering iron, make a hole to pass conductors into the body of master station.
- 4) Mount the handset to body of master station with supplied screws.
- 5) Connect the 12 conductors from the handset to the printed circuit board. For full information please refer to the instruction sheet packed with LAR-2.

NOTE: The LAF-10S with LAR-2 can not be mounted to wall.

ADJUSTING VOLUME CONTROLS

- 1) Fingertip adjustment ensures pleasant communication at desired level all the time.
- 2) Use screw driver to adjust volume control for call tone to desired level.

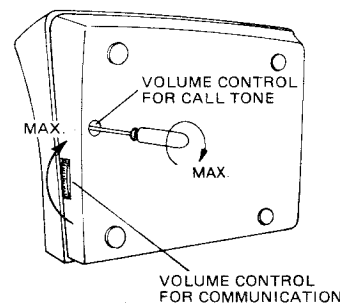

WIRING EXAMPLE

① LAF-10S ALL-MASTER SYSTEM WITH BG-1A/BG-1B ADAPTOR

The following diagram illustrates a full LAF-10S system, where all the LAF-10S stations can transmit and receive All Call and background music.

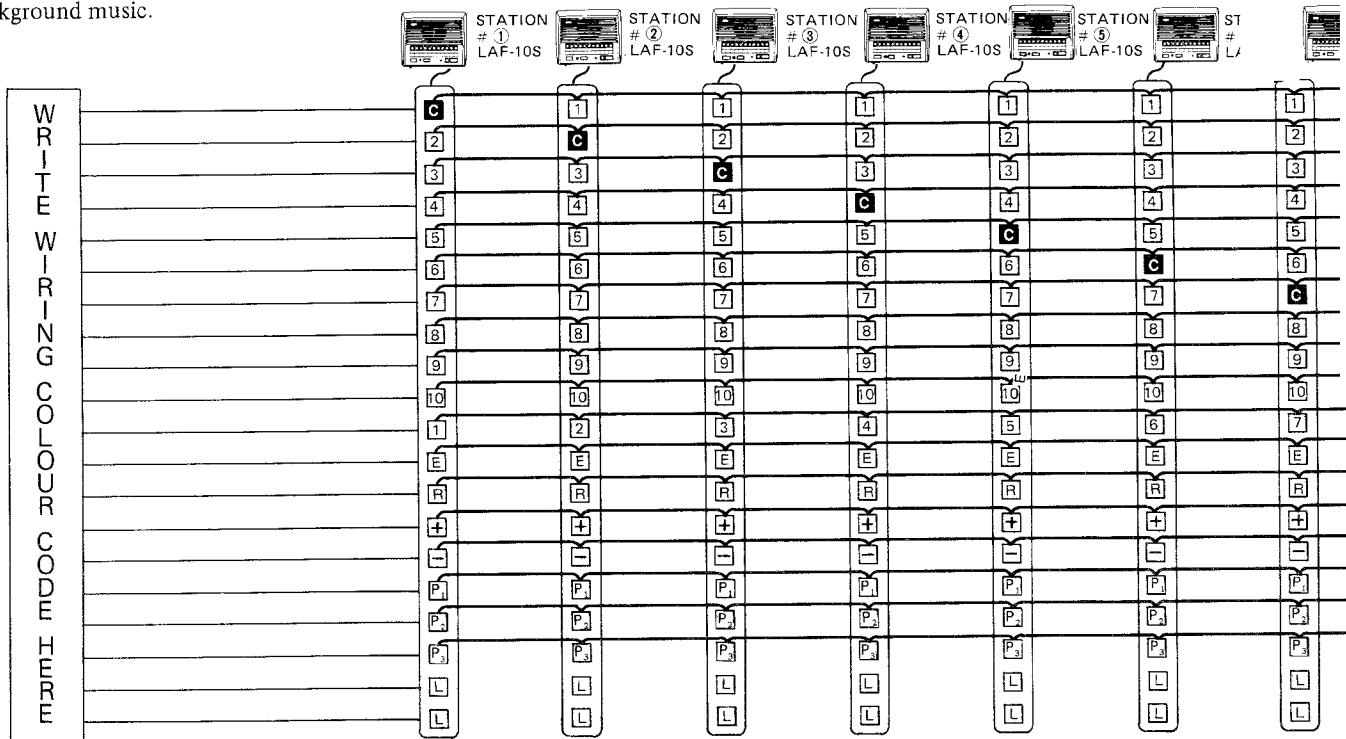

WIRING EXAMPLE

② LAF-10S SYSTEM WITH ONE DOOR STATION AND DOOR RELEASE

The following diagram shows how master stations Nos. 1 and 2 can receive a call from door station as well as activate electric door release. Any master station can transmit and receive All Call and background music.

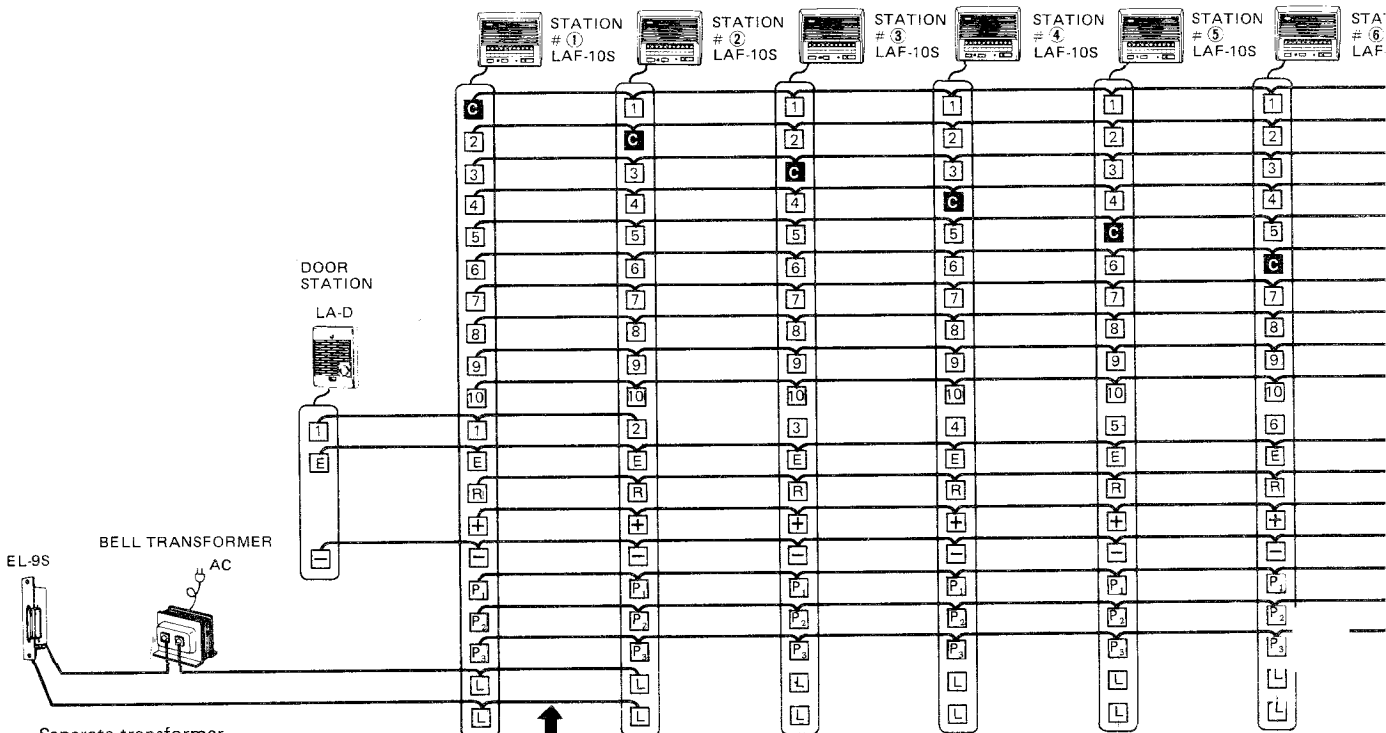

Separate transformer (not supplied by Aiphone) required to power door release.

* Wiring for door release should be separated from wiring for communication in order to avoid noise by activated door release.

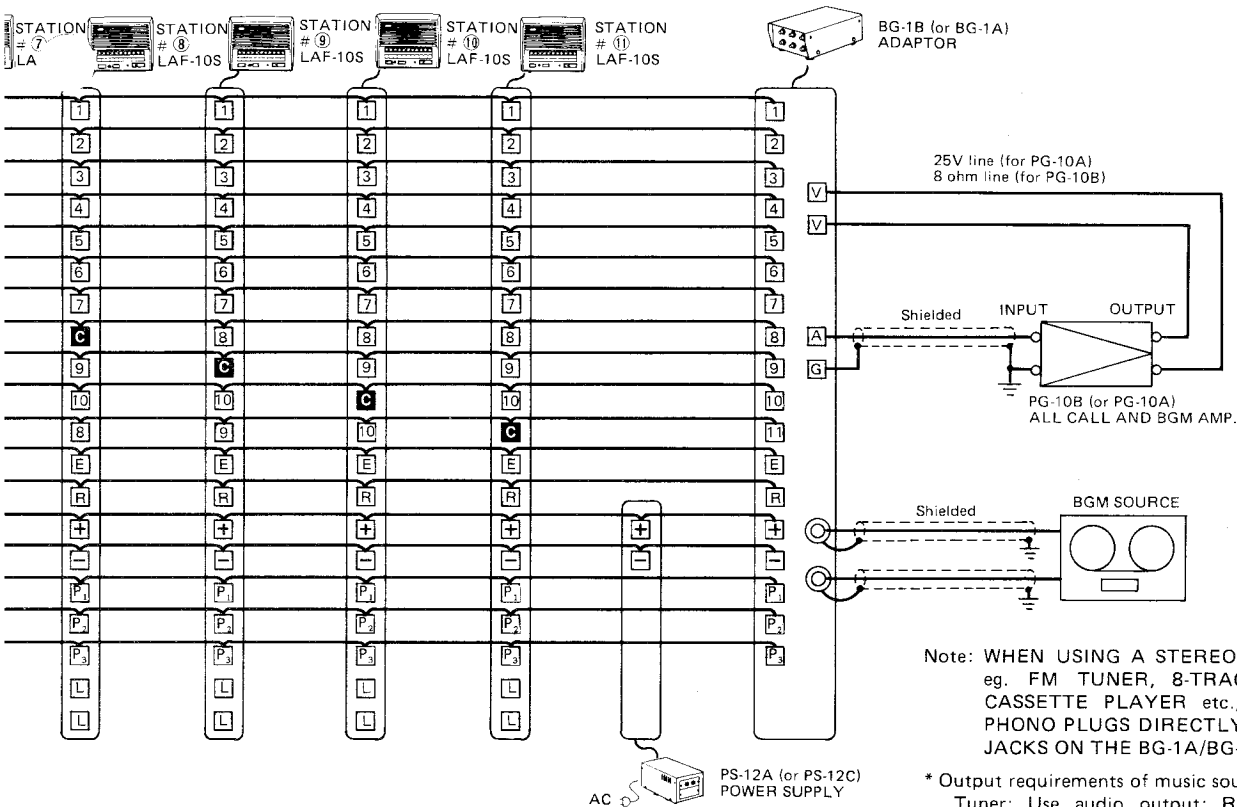

Note: WHEN USING A STEREO MUSIC SOURCE, eg. FM TUNER, 8-TRACK PLAYER OR CASSETTE PLAYER etc., CONNECT THE PHONO PLUGS DIRECTLY TO TWO PHONO JACKS ON THE BG-1A/BG-1B.

* Output requirements of music source:
Tuner; Use audio output: RANGE; 300mV ~ 1.2V, 10K ohm ~ 100K ohm.
Tape player; Use low level output: RANGE; 300mV ~ 1.2V, more than 600 ohm.

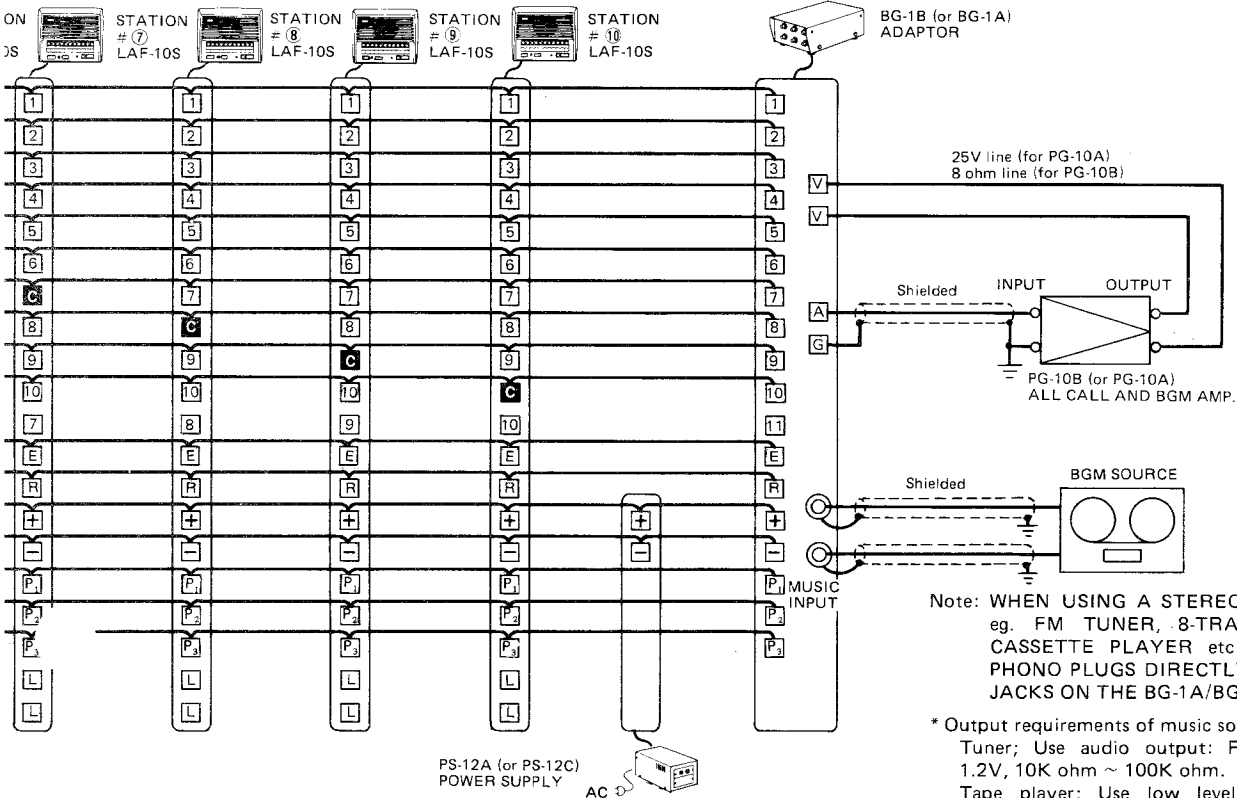

Note: WHEN USING A STEREO MUSIC SOURCE, eg. FM TUNER, 8-TRACK PLAYER OR CASSETTE PLAYER etc., CONNECT THE PHONO PLUGS DIRECTLY TO TWO PHONO JACKS ON THE BG-1A/BG-1B.

* Output requirements of music source:
Tuner; Use audio output: RANGE; 300mV ~ 1.2V, 10K ohm ~ 100K ohm.
Tape player; Use low level output: RANGE; 300mV ~ 1.2V, more than 600 ohm.

WIRING EXAMPLE

③ **LAF-10S INTERMIXED SYSTEM**

Master stations Nos. 6 and 7 may (1) communicate with sub stations Nos. 1 to 4 (2) operate electric door release and (3) transmit All Call, while the other master stations Nos. 1 to 5 can only receive All Call announcement and background music.

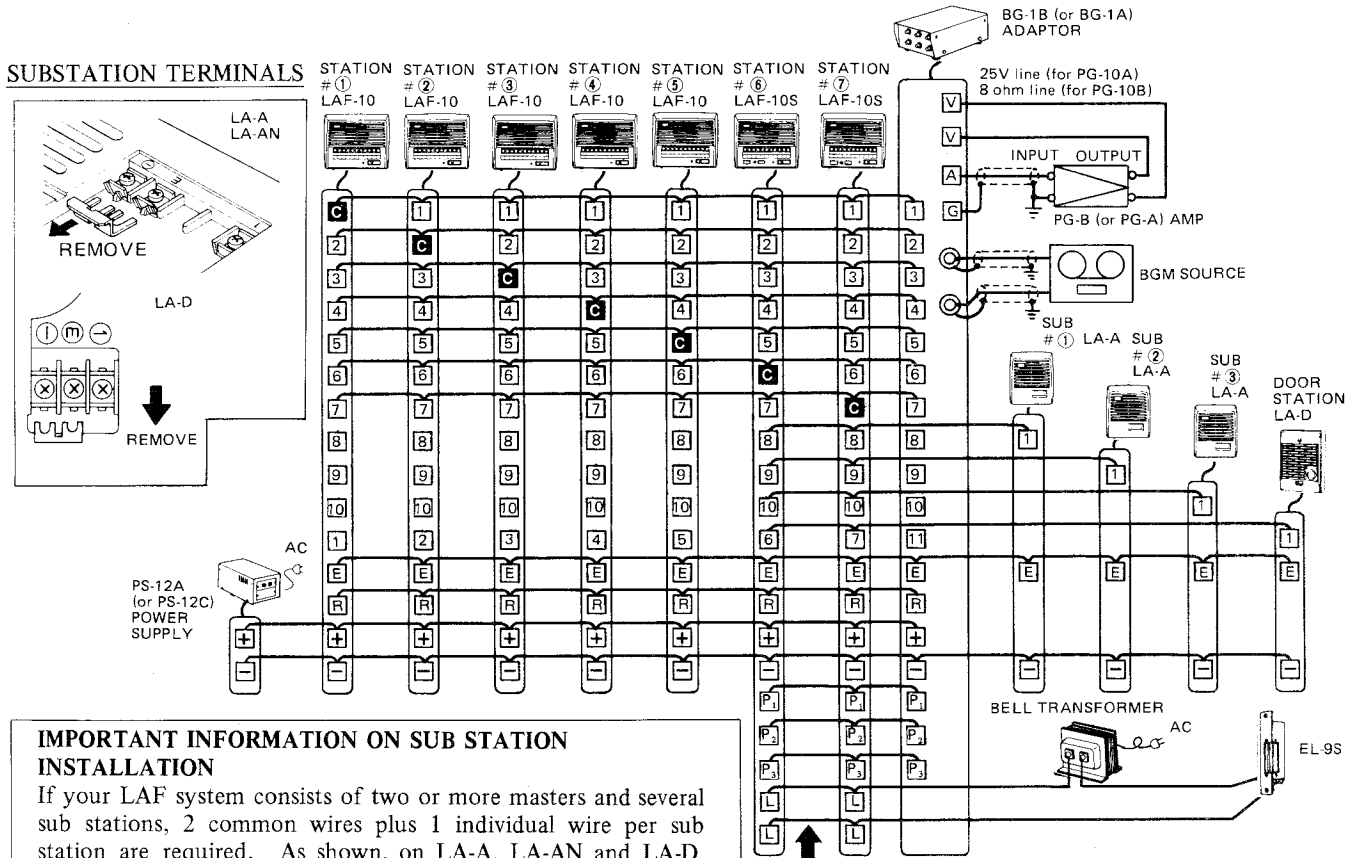

IMPORTANT INFORMATION ON SUB STATION INSTALLATION

If your LAF system consists of two or more masters and several sub stations, 2 common wires plus 1 individual wire per sub station are required. As shown, on LA-A, LA-AN and LA-D, remove the shorting link attached to terminals **E** and **-**.

* Wiring for door release should be separated from wiring for communication.

WIRING DIAGRAM

④ **LAF-10S ONE-MASTER SYSTEM, WITH DOOR RELEASE**

LAF-10S master station may reply to door station No. 10 and activate electric door release, as well as communicate with the other inside subs Nos. 1 to 9.

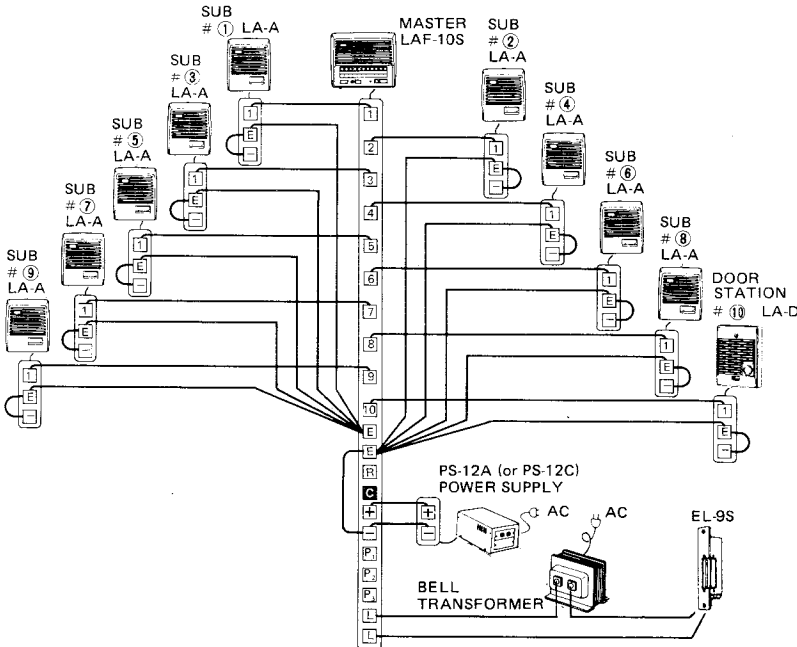

IMPORTANT INFORMATION ON SUB STATION INSTALLATION

If your LAF-10S system consists of one master and several subs, 2 wires per sub to master are required. It is necessary, on each sub, either LA-A, LA-AN or LA-D, that **E** and **-** terminals should remain shorted. As shown, on master terminal box, make a short between terminals **E** and **-**.

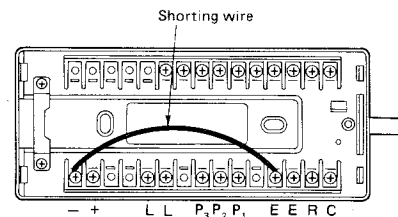

SUB STATION OPERATION

LA-A, LA-D & LA-AN;

1. Depress momentarily CALL button. You will hear a call tone. Wait for master to answer. After master replies, communication is hands free.
2. If no call tone is heard when a sub call button is depressed, the system is occupied with another conversation. Please call later.

LA-AN has PRIVACY switch which allows a call to be received from master but prevents sound going back to master. To place LA-AN in privacy mode, depress PRIV. button. To release PRIVACY switch, momentarily depress CALL button.

LA-A3 & LA-AN3;

1. Momentarily depress CALL button of desired master (unlock the PRIVACY switch first for LA-AN3). After master replies, communication from LA-A3 (or LA-AN3) is handsfree.
2. If no call tone is heard when call button is depressed, the system is occupied with another conversation. Please call later.
3. At conclusion of conversation, depress PRIVACY button (only for LA-AN3).

Note: Background music will be cut off temporarily if you press CALL button connected to BG-1A/BG-1B adaptor on LA-A3 or LA-AN3.

LA-A

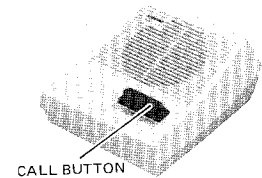

LA-D

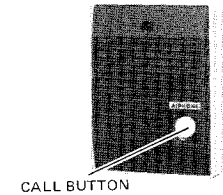

LA-AN

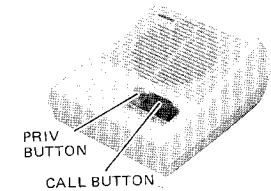

LA-A3

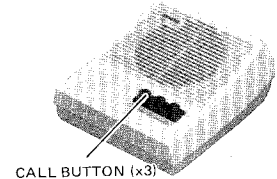

LA-AN3

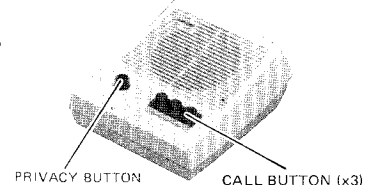

MASTER STATION OPERATION

*Illuminated OCCUPIED light indicates the other master is using the system. Please call later.

*Placing a call;

1. Depress a selector button of the station desired.
2. To call by tone, momentarily depress both PRIVACY and TALK buttons. To call by voice, depress TALK button and speak.
3. Depress TALK button to talk and release to listen. If using optional handset, use TALK switch in the handset to control communications.
4. Upon completing conversation, depress OFF button.

Note: LAF master station OFF button, when depressed, puts station in standby position as well as OFF position. OFF button MUST BE DEPRESSED and LOCKED DOWN on all master stations except station initiating a call or system will not work.

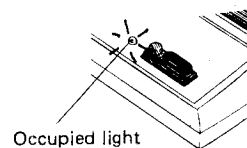

Occupied light

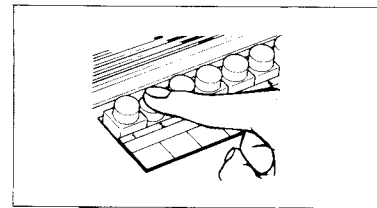

Call by tone

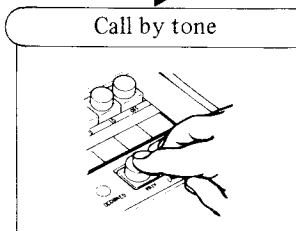

Call by voice

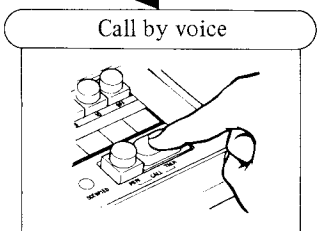

*Receiving a call from another master;

1. When your station is in non-privacy position, no action is required and communicate handsfree.
2. When your station is switched for privacy, release PRIVACY button by momentarily depressing TALK button, then resume handsfree operation. Or, if using optional handset, reply can be made privately using the handset.

Note: There is no LED annunciation between master stations except the occupied light.

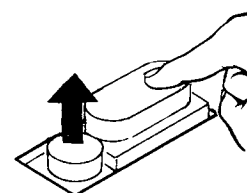

PRIVACY button pops up by momentarily depressing TALK button.

*Receiving a call from a sub station;

1. An incoming call is announced both by tone and light. Depress the selector button above the lighted annunciator light. (and the light goes off).
2. Depress TALK button to talk and release to listen. Upon completing conversation, depress OFF button.

Note: When you receive calls from another master and a sub at the same time, reply first to MASTER and, after the OCCUPIED light goes out, depress a selector button of the calling sub and communicate. **DO NOT DEPRESS THE SELECTOR BUTTON WHILE OCCUPIED LIGHT IS ILLUMINATED.**

*Operating electric door release;

When communicating with a door station, you may let the person in by activating the door release. Door lock is released while you depress and hold down door release button.

*All Call announcement;

1. Depress All Call button. A pre-tone will sound at the connected master station speakers. BGM is cut off automatically during All Call.
2. Make announcement while depressing and holding down TALK button.
3. After announcement, unlock All Call switch by pushing it.

Notes: (1) **DO NOT MAKE ALL CALL ANNOUNCEMENT WHILE OCCUPIED LIGHT IS LIT.**
(2) All Call through optional handset cannot be made.

*Distributing background music;

1. Turn on music ON/OFF switch on BG-1A/BG-1B as well as BGM source/amplifier. BGM will be distributed through the selected station(s). BGM is cut off automatically during communication.
2. When not distributing BGM, turn off music ON/OFF switch on BG-1A-1B.

Note: A call tone from a sub during BGM distribution, will be announced through all the master station speakers, while the annunciator light on the called master stays lit for about 20 seconds.

CLEANING YOUR INTERCOM STATIONS

*Your Aiphone intercom stations may be cleaned with a soft cloth dampened with household cleanser, such as Mr. Clean or Fantastik.

* * *

We at AIPHONE are proud of our products. Our designers and engineers strive to bring you the finest in communication equipment. Each item has been carefully tested and inspected before leaving our factory. Properly installed and used, your Aiphone intercom system should give years of trouble-free service.

We are pleased to offer the following warranty:

WARRANTY

Aiphone warrants its products to be free from defects of material and workmanship under normal use and service for a period of one year after delivery to the ultimate user and will repair free of charge or replace at no charge, should it become defective upon which examination shall disclose to be defective and under warranty. Aiphone reserves unto itself the sole right to make the final decision whether there is a defect in materials and/or workmanship; and whether or not the product is within the warranty.

This warranty shall not apply to any Aiphone product which has been subject to misuse, neglect, accident, or to use in violation of instructions furnished, nor extended to units which have been repaired or altered outside of the factory.

This warranty does not cover batteries or damage caused by batteries used in connection with the product.

This warranty covers bench repairs only, and any repairs must be made at the shop or place designated in writing by Aiphone. Aiphone will not be responsible for any costs incurred involving on site service calls.

Aiphone Co., Ltd., Nagoya, Japan
Aiphone Corporation, Bellevue, Washington
LAF-10S INSTRUCTIONS (E)

INTERCOM SYSTEMS
AIPHONE
HOME, BUSINESS, INDUSTRY
PRINTED IN JAPAN