

**VIDEO SENTRY PanTilt Plus
PANTILT VIDEO ENTRY SECURITY INTERCOM**

Models: **MY-2CD**, *Master station with monitor*
MYH-2CD, *Sub station with monitor*

INSTALLATION & OPERATION MANUAL

This Manual and the Markings on the product contain various symbols in order that the product can be used safely and properly, and that the installer and user are protected from injury and property damage.

The following precautions must be thoroughly read and understood before proceeding.

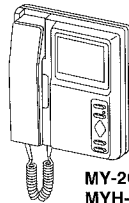



MY-2CD
MYH-2CD



















PACKAGE CONTENTS

- Master station w/monitor MY-2CD or Sub station w/monitor MYH-2CD
- Packet of screws
- Installation & Operation Manual

PRECAUTIONS ON INSTALLATION & WIRING

-  **WARNING** *Negligence could result in death or serious injury.*
-  **CAUTION** *Negligence could result in injury or damage to property.*









The following precautions also apply to MYH-2CD sub station with monitor.

-  **WARNING**
 1. Do not connect any power source other than specified to terminals +, – on MY-2CD. Fire or damage to the unit could result. 
 2. Do not open MY-2CD. High voltage is present inside, and it can cause electric shock. 
 3. Do not change or alter MY-2CD. It can cause fire or electric shock. 
 4. Make sure wires are connected properly before plugging in power supply. 
 5. Keep the MY-2CD unit away from water or any other liquid. Fire or electric shock could result. 
 6. Do not put any forcible strength on the video monitor. Damage may result. 
 7. Keep AC plug away from moisture or dust. 
 8. Keep AC cord away from being marred or crushed. 
 9. Do not plug or unplug with wet hands. 
 10. Do not put any metal into MY-2CD through openings. It can cause fire, electric shock or unit damage. 
-  **CAUTION**
 1. Do not install or make any wire terminations while power supply is plugged in. It can cause electrical shock or damage to the unit. 
 2. Do not manually hold down hook switch to verify chime volume. It sounds very loud in the handset, and can cause hearing damage. 
 3. Mount MY-2CD on wall in a convenient location, but not where it could be bumped or jarred. 
 4. In case of electrical storms, unplug power supply from AC outlet. It can cause fire, electric shock, or power surge damage.
 5. Do not install MY-2CD components in any of the following locations, as it may cause the system to malfunction; 
 - **High or extreme cold temperature area:** under direct sunlight, near equipment that varies in temperature, in front of air conditioner, inside a refrigerated area, etc.
 - **Places subject to moisture or humidity extremes.**(bathroom, cellar, greenhouse, etc.) 
 - **Places subject to environmental conditions,** such as oil, dust, chemicals, salt, etc. 
 - **Places subject to constant vibration or impact.**
 - **Places where noise generating devices** such as TV or radio are close by.

 **GENERAL PRECAUTIONS**

1. MY-2CD equipment, except for door station MK-DBC, etc. is designed for indoor use only. Do not install outdoors.
2. MY-2CD system is not operational during a power failure.
3. In areas where broadcasting station antennas are close by, intercom system may be affected by radio frequency interference.
4. Keep all DC wiring at least 30cm(1') away from AC 100~240V wiring, fluorescent lighting, or dimmer switches. Otherwise, cross AC wiring at a 90° angle.

Examples of Symbols;

-  **GENERAL PRECAUTIONS:** –  mark indicates caution statement (incl. danger and warning), which is specifically shown inside.
-  **GENERAL INSTRUCTIONS:** –  mark indicates contents which demands a specific action shown inside or attached.
-  **GENERAL PROHIBITIONS:** –  mark indicates contents which prohibit a specific action shown inside or attached.
 -  **DISMANTLE PROHIBITIONS**
 -  **MOISTURE PROHIBITIONS**

1 SYSTEM OUTLINE & COMPONENTS

MY-2CD is a master station for PanTilt Video Entry Security Intercom, which can incorporate max. 2 PanTilt video door stations and up to 3 monitor stations. Audio only door station and audio-only handset sub station are optional.

SYSTEM LAYOUT

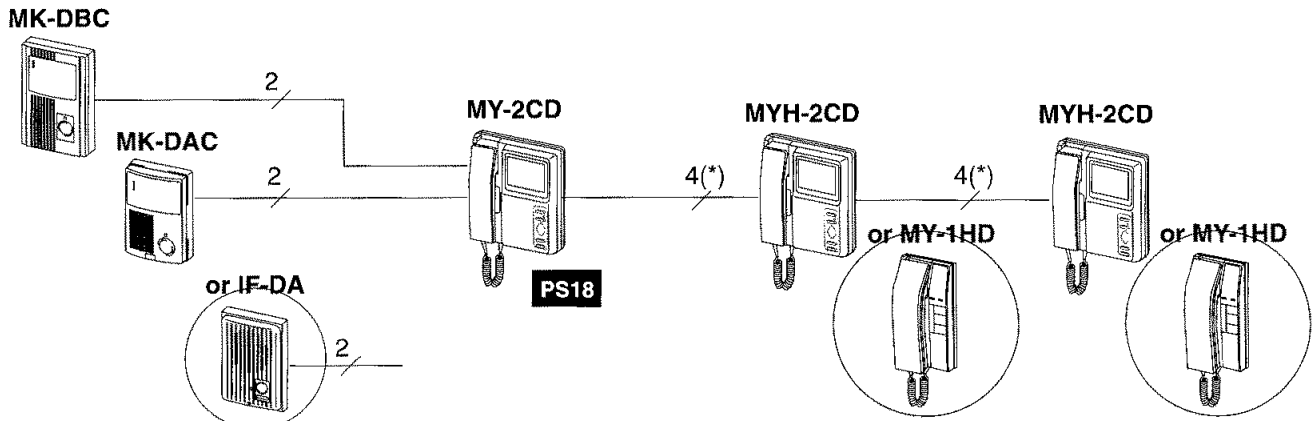

(*) 4 or 6 when +, - wires are doubled.

PS18 : PS18: PS-18C or PS-18E

COMPONENTS AVAILABLE

MY-2CD, Master station w/monitor
MYH-2CD, Sub station w/monitor
MY-1HD, Audio-only sub station

MK-DBC, PanTilt video door station, semi-flush
MK-DGC, PanTilt, w/aluminum cover
MK-DAC, PanTilt, surface mount
MY-DS, Wide-angle fixed camera door station
IF-DA, Audio door station (any IE/IF series)

Other models
MY-DC/A, MY-DG/A, MY-EA, MY-FA, MY-CA

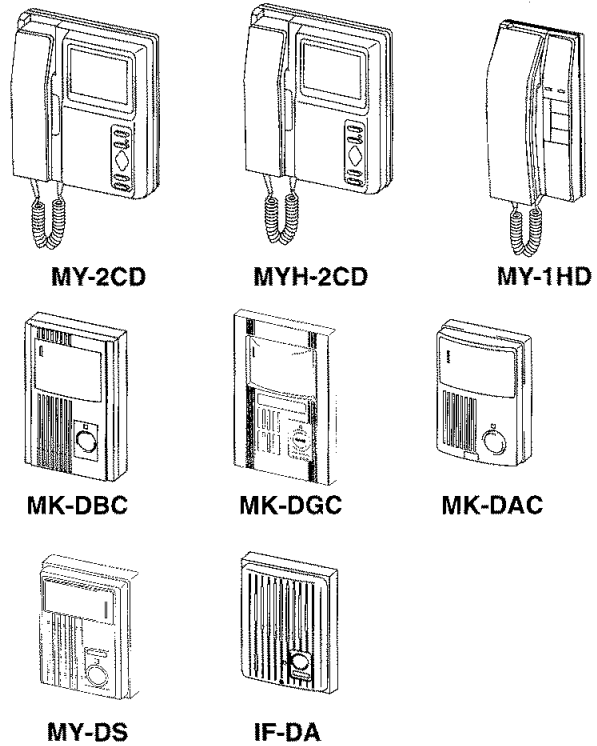

OPTIONS

MYW-BA, Long distance adaptor
RY-3DL, Door release adaptor
KC-32EU, Picture memory unit
IER-2, Call extension speaker

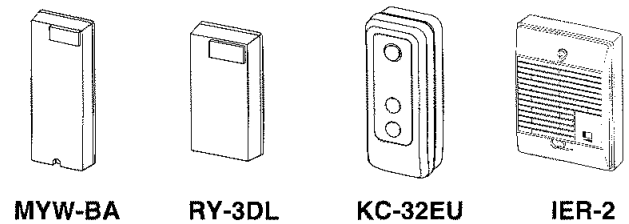

Mounting accessories

MKW-R, Surface mount box for MK-DBC, MK-DGC.
KAW-D, 30° Angle Box for surface mount video door stations MK-DAC, MY-DS.
MCW-S, Desk stand for MY-2CD, MYH-2CD.

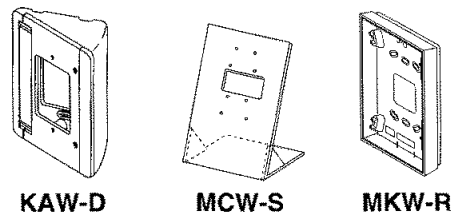

2 NAMES & FEATURES

MY-2CD, MYH-2CD

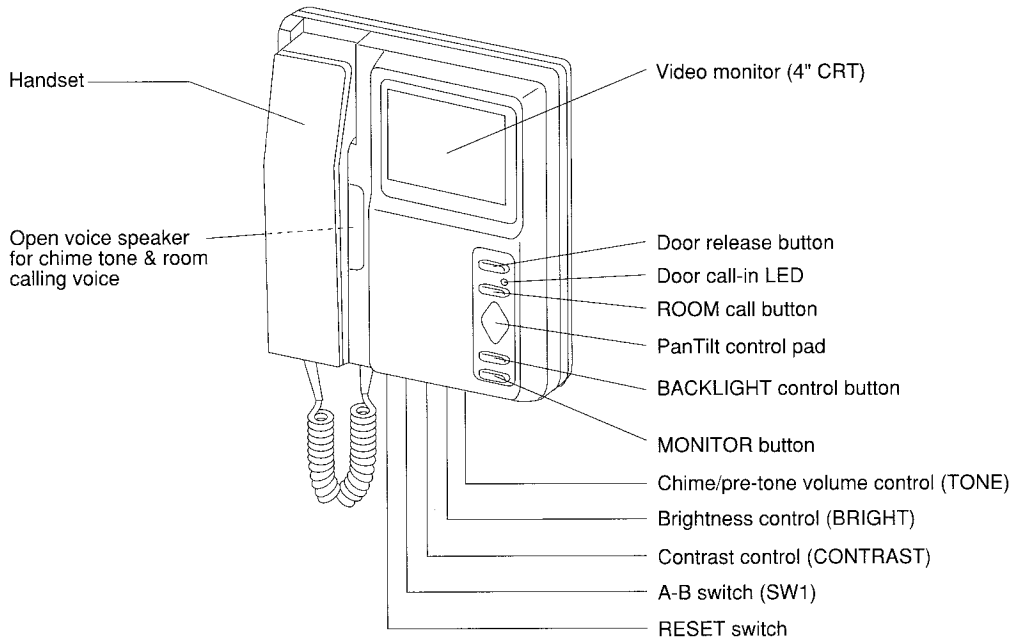

FEATURES

- Multiple PanTilt door & monitor system with a variety of configurations.
- Max. 3 inside monitor stations. Audio-only sub station(s) in place of sub station(s) w/monitor.
- Max. 2 PanTilt door stations.
- Optional audio door station.
- Monitor audio & video handsfree.
- All call type internal calling and communication.
- Door release button. Selective door release control with RY-3DL adaptor.

3 INSTALLATION

⚠ Precautions on wiring

1. Use parallel conductor cable to connect video door station. Do not use any other cable like coax cable, individual wires, shielded wire, or twisted pair.
2. When existing chime wires are used, be sure to locate and disconnect the AC transformer.
3. If unused wires exist in the cable, terminate each extra pair with a 120 Ohm resistor at each end of wires (on audio sub station end as well). Extra wires can interfere with video signal.
4. Keep audio/video wires more than 30cm(1') away from AC100~240V power lines. It will cause noise in communication and possible malfunction.
5. Run internal wiring of audio/video system in such a manner that the cable is run from master to sub without any splices, which will create inferior video quality.

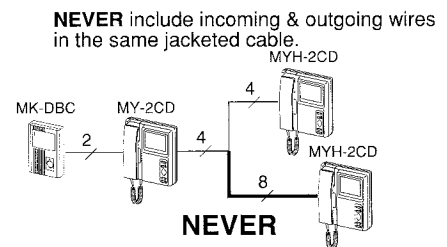
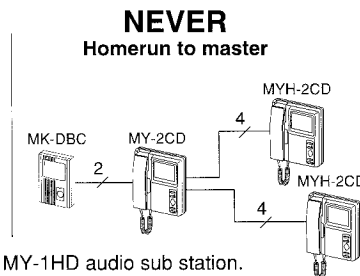
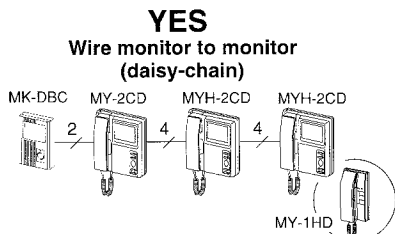
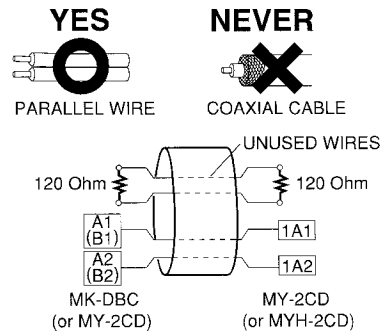

Note: The above wiring method also applies to MY-1HD audio sub station.

3 INSTALLATION (continued)

Mounting locations & height

Do not install master & sub stations with monitor in a place strongly sunlit.

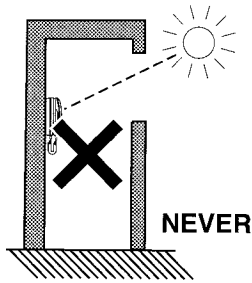

Mount the station so that the video monitor comes at the user's eye level.

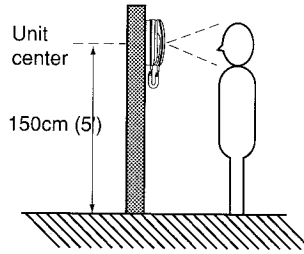

System selector "SW1" setting

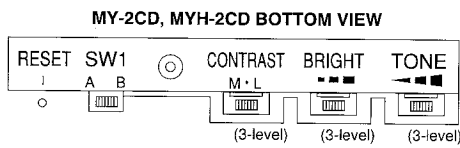

On MY-2CD master station, do not change A setting. Only on 2nd (middle) sub station of 3-station system, either MYH-2CD or MY-1HD, set to B position (for impedance-matching).

Note: When MY-2CD is used for Aiphone VY-EM Condo. System, change setting to B position on MY-2CD.

"RESET" switch setting

After completing all the wiring and turning on the power supply, operate as follows;

The system will automatically initialize when powered on.

To re-initialize when powered on, press RESET switch on one room station (any). The call-in LED lights, then goes off in 15 to 30 seconds (approx.) and the system becomes operable. The RESET switch operation becomes necessary when power supply is turned off and on (after power failure, etc.).

Call extension

One IER-2 call extension speaker can be added to sound a chime tone in a remote location. Connect wires from S+, - terminals on MY-2CD.

Power supply

Use specified power supply to ensure proper system operation.

If communication has noise interference, connect GND of power supply to ground.

4 WIRING DIAGRAMS

1. Two PanTilt video door stations

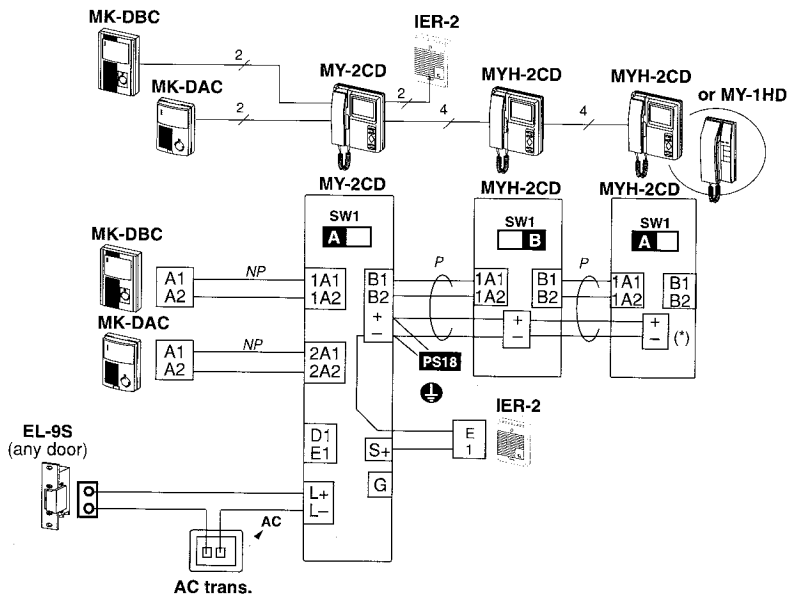

• **Cable:** Total of 6 wires with +, - wires doubled

2-monitor system		3-monitor system	
Ø1.0mm	Ø1.0mm	Ø1.0mm	Ø1.0mm
56m (4 wires)	75m (6 wires)	28m (4 wires)	56m (6 wires)

• **Video impedance matching with SW1**

MY-2CD: "A" remains unchanged.
MYH-2CD: Switched to "A" on the last station.

• **AC transformer:** 12V AC, 0.35A for EL-9S (PT-1210N in USA)

PS18: PS-18C or PS-18E

Take G terminal to earth ground.

2. One each PanTilt video & audio door station

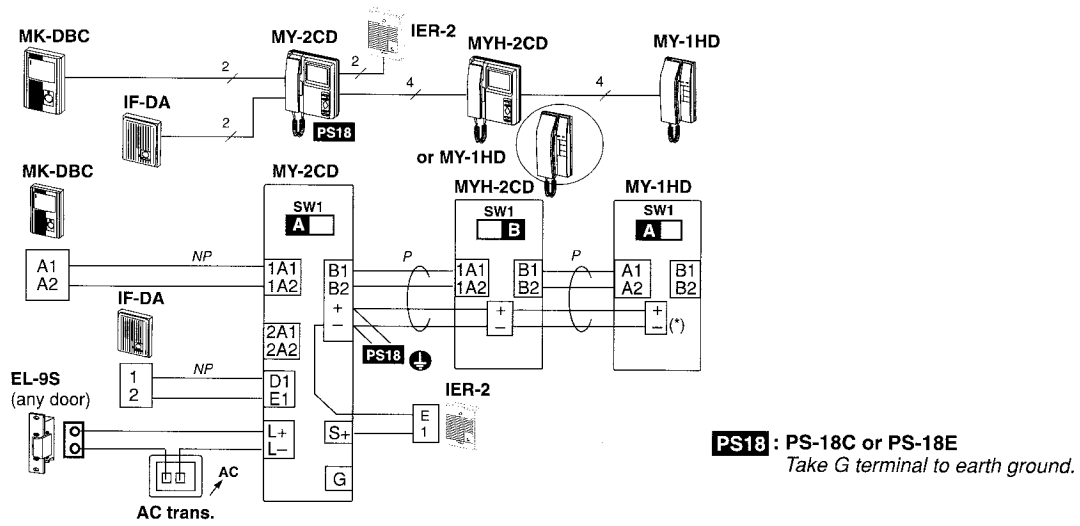

3. Long-distance application with MYW-BA

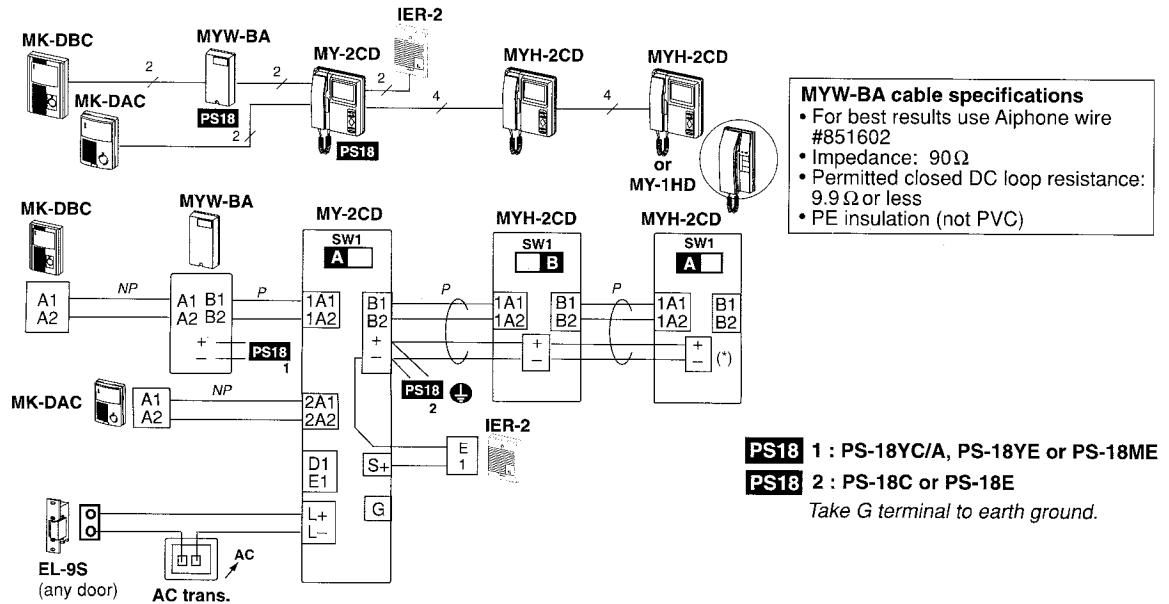

4 WIRING DIAGRAMS (continued)

MY-2CD with 2 door releases

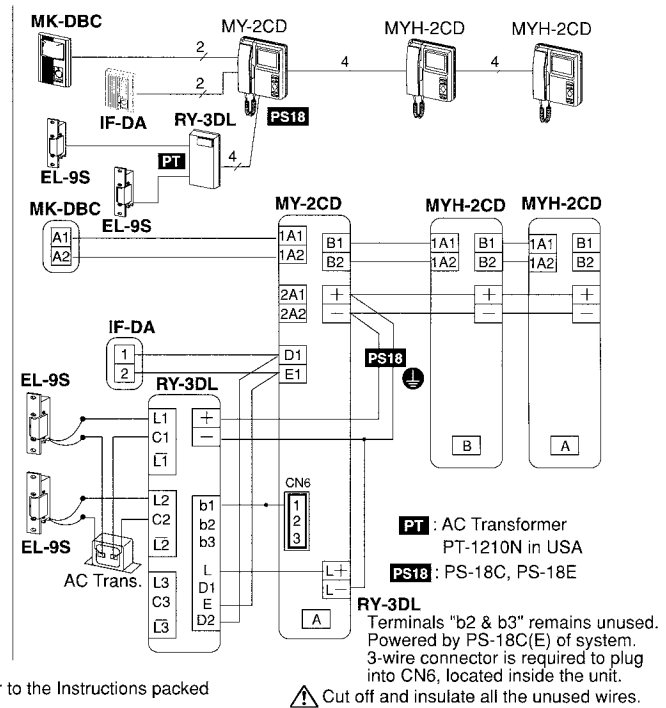
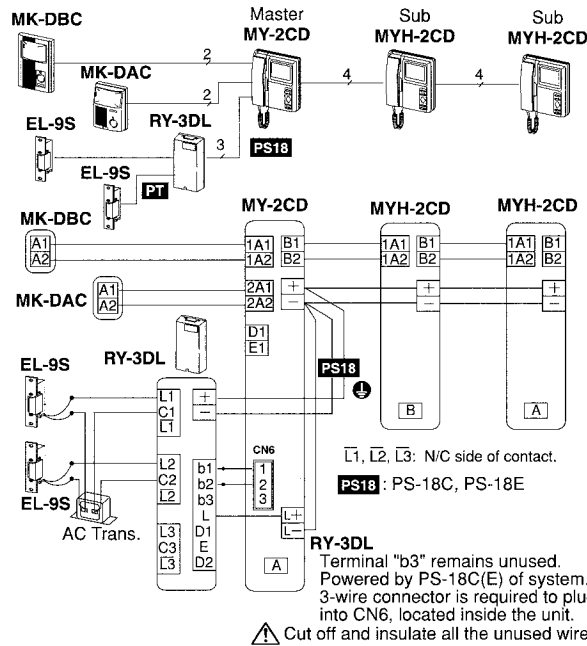

For actual wiring, refer to the Instructions packed with the RY-3DL.

KC-32EU Picture Memory Unit

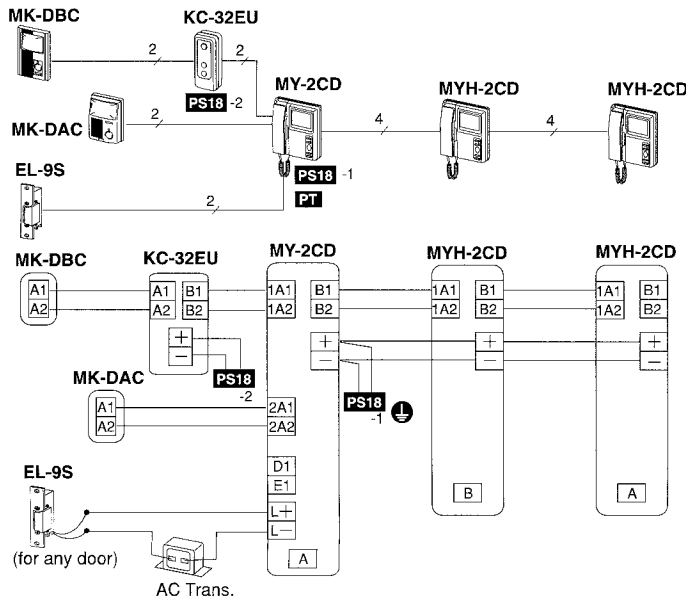

5 MOUNTING

MY-2CD & MYH-2CD master & sub stations can either be wall-mounted or placed on a desk stand (Model: MCW-S).

MY-2CD
MYH-2CD

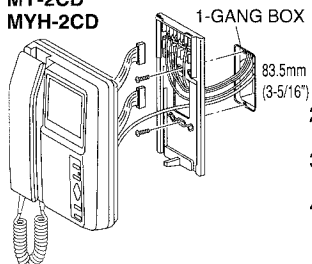

Wall-mounting

- Loosen screw on bottom of front case, and separate the front case from chassis by sliding the front case upward and pulling away. Disconnect the front case from the chassis, unplugging two connectors. Do not force the unit apart.
- Install the chassis to single-gang box or to wall surface.
- Terminate all the wires on screw terminals inside the chassis.
- When wiring is completed, reconnect the front case to the chassis. Aligning from the top, slide the front case downward on chassis into place. Tighten screw at bottom of the front case.

Desk-top mounting on MCW-S

MY-2CD
MYH-2CD

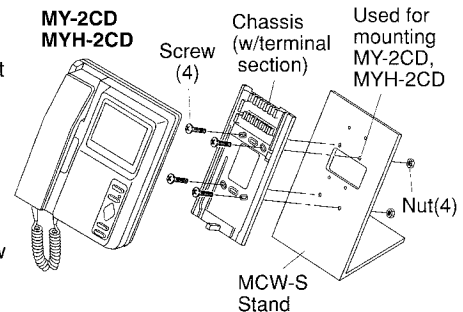

6 OPERATIONS

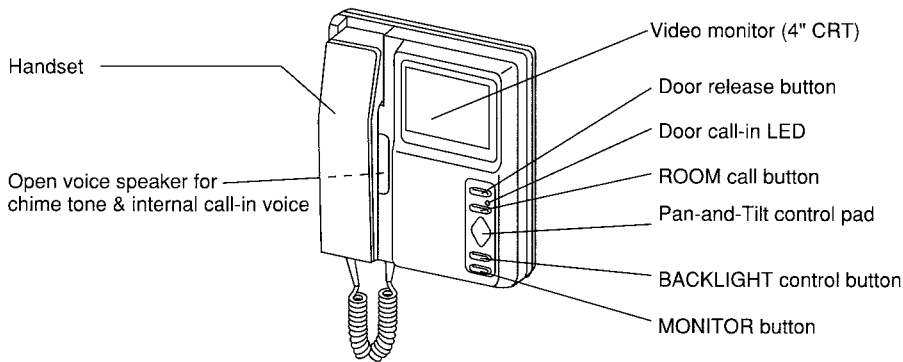

Pan-and-Tilt door camera

When a door call is received or when monitoring a door, press the edge of control pad to move the door camera up, down, or side to side. Backlight control button adjusts for extreme light.

Answer door

A visitor presses momentarily CALL button on a door station. At all inside stations, 4- or 2-tone chime sounds and monitor turns on with image (8-tone chime from audio door station). On any inside station, pick up handset to reply. The rest inside stations turn off. If not replied, video monitors turn off in approx. 45 sec. automatically.

To activate door release; After identifying a caller, press and hold door release button.

Monitor door audio & video handsfree

In standby, press MONITOR button to view and hear the door station. Press once for door one, press twice for door two (if included). Monitor will stay on for approx. 2 1/2 min. Press MONITOR button to turn monitor off.

Internal communication

Pick up handset on any inside station and press ROOM call button. After pre-tone sounds at other stations, make announcement into handset.

MY-1HD sub station also receives pre-tone and voice.

When door calls in during communication;

Chime tone is heard at communicating stations and monitor turns on with image. Hang up handset at both stations to end present call.

Pick up handset again to answer the door.

Connect audio door station

To monitor the audio of an IE/IF door station, pick up handset and press MONITOR button twice. (Separately from the above operation "Monitor audio & video")

MY-2CD, MYH-2CD BOTTOM VIEW

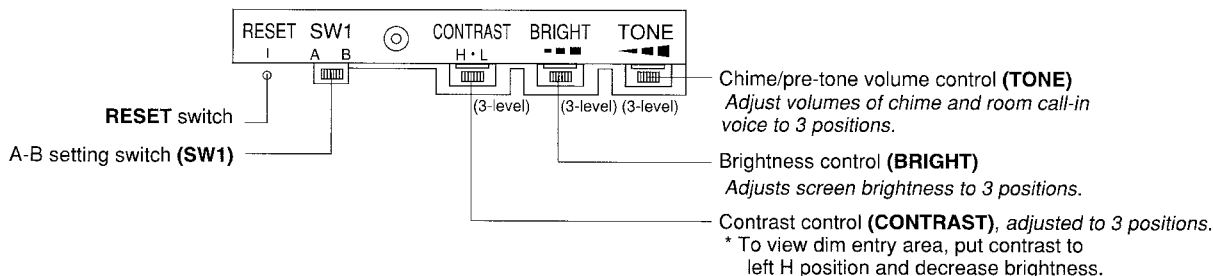

7 TECHNICAL PRECAUTIONS

Before asking for repairs: In case the system does not provide satisfactory performance, check possible causes, such as; Unplugged? Disconnected wire? Shorted wire?

If the system continues to malfunction, consult the dealer or distributor that you purchased the product from.

Do not open any monitor station without first unplugging power supply. High voltage is present inside the monitor.

When an inside station does not place a normal call, press RESET switch on that station. This RESET switch operation is necessary if power supply is unplugged and plugged in again.

When the outside temperature lowers rapidly (after rain, etc.), the camera lens may be fogged and display a dim image on the video monitors. This is not a malfunction, and will return to normal shortly.

Cleaning: Clean your MY-2CD equipment with a soft cloth dampened with neutral household cleanser. Video door station is designed to be weather resistant. Do not spray high-pressure water directly onto door station.

8 SPECIFICATIONS

- Power source: DC 18V.
- Power supply: PS-18C (AC 120V) or PS-18E (AC220 ~ 240V).
- Consumption:
- Call-in: Door call-in with 4- or 2-tone chime and image approx. 45 sec. (8-tone from audio door). Pre-tone and voice from other inside station.
- Communication: Simultaneous with handset. (MY-2CD & MYH-2CD)
- Dimensions: 230 H x 195 W x 69 D (mm). 9" H x 7-1/2" W x 2-3/4" D.
- Weight: Approx. 1,500g (3.31 lbs.).

	Max.	Standby
MY-2CD & 2 video doors	1.0A	0.14A
MY-2CD & one MYH-2CD	1.48A	0.21A
MY-2CD & two MYH-2CD	1.96A	0.28A

- Video monitor: 4 inch direct view flat CRT. Scanning line: 525 lines.
- Wiring distance: **MY-2CD to PanTilt door station;**

Diameter	0.65mmø	1.0mmø
Distance	50m	100m
AWG	22AWG	18AWG
Distance	165'	330'

MY-2CD to MY-DS fixed wide-angle;

Diameter	0.65mmø	1.0mmø
Distance	100m	200m
AWG	22AWG	18AWG
Distance	330'	650'

MY-2CD to IE/IF door (audio);

Diameter	0.65mmø	1.0mmø
Distance	150m	360m
AWG	22AWG	18AWG
Distance	450'	1,000'

Between inside monitor stations;

2-monitor system;

Diameter	1.0mmø	(*)1.0mmø
Distance	56m	75m
AWG	18AWG	(*)18AWG
Distance	185'	245'

3-monitor system;

Diameter	1.0mmø	(*)1.0mmø
Distance	28m	56m
AWG	18AWG	(*)18AWG
Distance	90'	185'

(*) Total of 6 wires, with +, - wires doubled.

This equipment has been tested and found to comply with the limits for a Class B digital device, pursuant to Part 15 of the FCC Rules. These limits are designed to provide reasonable protection against harmful interference in a residential installation. This equipment generates, uses, and can radiate radio frequency energy, and if not installed and used in accordance with the instructions, may cause harmful interference to radio communications. However, there is no guarantee that interference will not occur in a particular installation. If this equipment does cause harmful interference to radio or television reception, which can be determined by turning the equipment off and on, the user is encouraged to try to correct the interference by one or more of the following measures:

- Reorient or relocate the receiving antenna.
- Connect the equipment into an outlet on a circuit different from that to which the receiver is connected.
- Increase the separation between the equipment and receiver.
- Consult the dealer or an experienced radio/TV technician for help.

WARRANTY

Aiphone warrants its products to be free from defects of material and workmanship under normal use and service for a period of two years after delivery to the ultimate user and will repair free of charge or replace at no charge, should it become defective upon which examination shall disclose to be defective and under warranty. Aiphone reserves unto itself the sole right to make the final decision whether there is a defect in materials and/or workmanship; and whether or not the product is within the warranty.

This warranty shall not apply to any Aiphone product which has been subject to misuse, neglect, accident, or to use in violation of instructions furnished, nor extended to units which have been repaired or altered outside of the factory.

This warranty does not cover batteries or damage caused by batteries used in connection with the unit.

This warranty covers bench repairs only, and any repairs must be made at the shop or place designated in writing by Aiphone.

Aiphone will not be responsible for any costs incurred involving on site service calls.

AIPHONE CO., LTD., NAGOYA, JAPAN
 AIPHONE CORPORATION, BELLEVUE, WA, USA
 AIPHONE EUROPE N.V., ANTWERP, BELGIUM

