

MY Series PanTilt VIDEO DOOR STATIONS

Models: **MY-EA**
MY-FA

INSTALLATION & OPERATION MANUAL

1 SYSTEM OUTLINE & FEATURES

MY-EA & MY-FA are semi-flush mount pan and tilt video door stations, which can be used with any Aiphone MY video system (MY-1CD, MY-2CD, MY/IE, MY/TD-H, MY/LEF).

For 1 entry;

MY-1CD MY-CU MYW-P1L



Connecting Terminals: A1, A2 1A1, 1A2 A1, A2

For 2 or max. 3 entries;

MY-2CD MYW-P3CB MYW-P3L

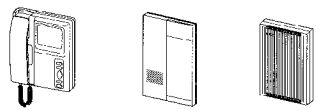

Connecting Terminals: 1A1, 1A2, 2A1, 2A2 1A1, 1A2, 2A1, 2A2, 3A1, 3A2 1A1, 1A2, 2A1, 2A2, 3A1, 3A2

PACKAGE CONTENTS

- PanTilt video door station (MY-EA or MY-FA)
- Tamper-proof screwdriver



- Packet of screws
- Installation & Operation Manual

FEATURES

- Audio, video, and PanTilt control on 2 wires
- Pan and tilting of door camera
- 100m, 330' from camera to monitor on 1.0mm dia., 18AWG wire
- Extended distance to 300 m, 980' with MYW-BA adaptor (using 1.2mm dia., 16AWG PE jacketed wire)
- Can replace an existing doorbell using the same wire (remove existing transformer)

LAYOUT EXAMPLE

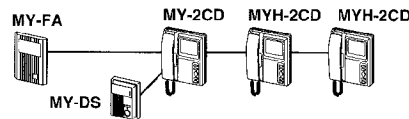

★ Refer to the Installation & Operation manual packed with main monitor or adaptor.

2 NAMES AND FUNCTIONS

MY-FA

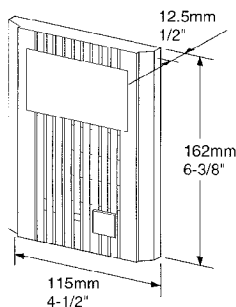

MY-EA

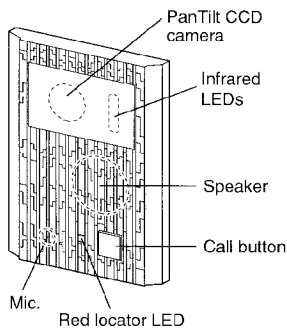

The MY-EA/FA, when measured at 50 cm, 20" from the camera, views an area of 51 cm, 20" vertically by 72 cm, 29" horizontally. On any and every inside monitor, operate Pan/tilt control pad to maximize viewing area, and Backlight button to view dimly lit or strongly backlit areas.

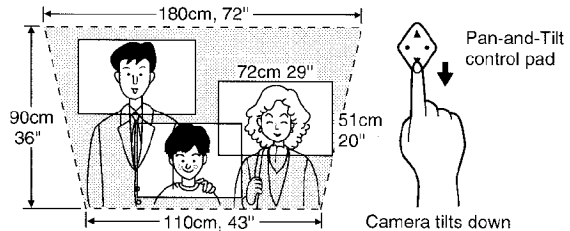

Image on edges of monitor is slightly distorted.

3 INSTALLATION & WIRING

Wiring

Use 2-conductor (parallel) cable. Coaxial cable or 2 separate wires should not be used.

Parallel conductor cable

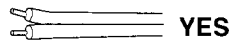

- ★ When existing chime wires are used, it is possible that the wires may contain AC voltage current. Locate and remove the bell transformer before actually connecting MY-EA/FA.
- ★ Extra pair(s) in the installed cable can affect image quality, and must be terminated with a 120 ohm resistor at each end of wires on both MY-EA/FA and inside monitor(s).

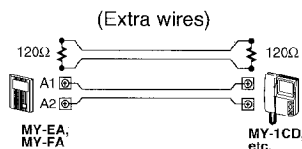

Installation

MY-EA/FA employs a CCD camera, and its performance can be affected by bright direct light, such as strong sunlight, gate light or street or porch light which is directed into the camera lens. Use backlight button to compensate for silhouetted images.

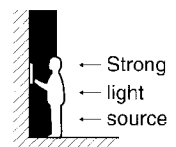

4 MOUNTING

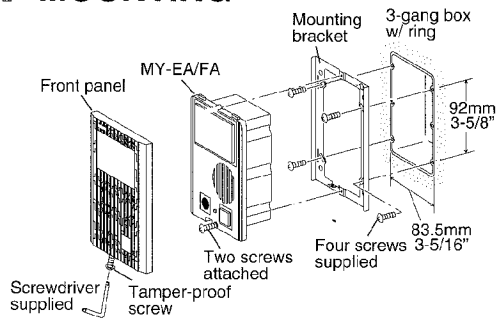

- ★ Before wiring on MY-EA/FA, make sure using video monitor is not powered.
- 1. Loosen the front bottom screw using supplied screwdriver, and lift off front panel.
- 2. Loosen 2 screws on MY-EA/FA to separate mounting bracket.
- 3. Attach the bracket to 3-gang box ring with 57mm, 2-1/4" depth secured. Note UP-direction marking.
- 4. Connect 2 parallel wires on non-polarized A1, A2 terminals with secured insulation.
- 5. Mount unit on mounting frame and reattach front panel.
- ★ Do not apply any sealant around MY-EA/FA front panel, as openings are provided for ventilation.

5 WIRING

Wiring is non-polarized with 2 parallel wires on A1, A2 terminals of MY-EA/FA.

Wiring distance: MY-EA/FA to Video-monitor MY-1CD, etc.

Diameter	0.65mm	1.0mm	AWG	22AWG	18AWG
Distance	50m	100m	Distance	165'	330'

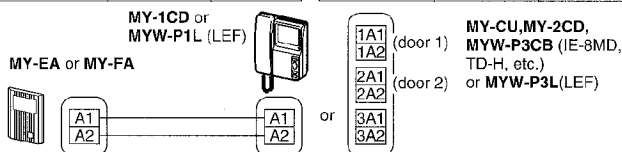

6 OPERATIONS

The red LED is lit to locate call button, day or night. A single push of Call button activates inside video monitor, as well as a 4 or 2-tone chime (or other). When inside station replies, talk handsfree.

Poor lighting conditions:

The MY-EA/FA's infrared illumination will light the image of the caller when positioned within 50cm, 20" in front of the camera, and will see in near darkness (1 Lux of light).

7 TECHNICAL PRECAUTIONS

MY-EA/FA has a camera angle presetting feature, programmable on inside video monitor. Refer to each Manual of MY-1CD, MY-2CD, etc.

- **Installation location:**
The MY-EA/FA is weather resistant, but for best results it should be protected from direct weather conditions. An eave or overhead cover is recommended to protect it from direct rainfall.
- **Temperature:**
The MY-EA/FA is rated to operate at temperatures between -10° and 60°C (14° and 140°F).

When the outside temperature lowers rapidly, the camera lens may fog up slightly, causing a blurry picture at the inside monitor. The ventilation openings will allow the moisture to evaporate, and the picture will return to normal.

- **Cleaning:**
Clean the unit with a soft cloth and neutral household cleanser. Do not use an abrasive cleaner or cloth.

8 SPECIFICATIONS

Power source	Camera is powered from monitor unit
Camera unit	CCD camera
Scanning lines	525 lines
Image viewing area	at 50 cm, 20" from camera Vertical 90cm, 3'. Horizontal 180cm, 6' (140cm, 47" in still position) when panned and tilted fully 1 Lux at 50cm, 20" from camera
Minimum illumination	MY-EA/FA
Dimensions & weight	162mm high x 115mm wide x 12.5mm deep. Approx. 400g. (0.88 lbs.) H6-3/8" x W 4-1/2" x D 1/2". Recessed 43mm, 1-11/16".

■ Pan/tilt viewing area shown by dotted line

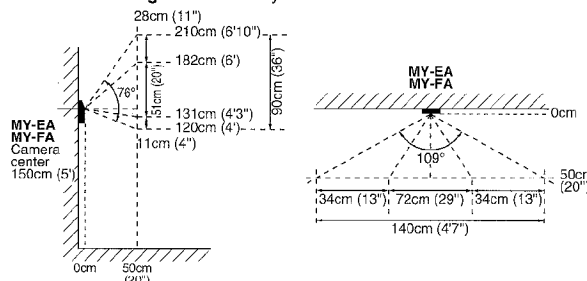

Viewing area of camera fixed in still position.

This equipment has been tested and found to comply with the limits for a Class B digital device, pursuant to Part 15 of the FCC Rules. These limits are designed to provide reasonable protection against harmful interference in a residential installation. This equipment generates, uses, and can radiate radio frequency energy and, if not installed and used in accordance with the instructions, may cause harmful interference to radio communications. However, there is no guarantee that interference will not occur in a particular installation. If this equipment does cause harmful interference to radio or television reception, which can be determined by turning the equipment off and on, the user is encouraged to try to correct the interference by one or more of the following measures:

- Reorient or relocate the receiving antenna.
- Connect the equipment into an outlet on a circuit different from that to which the receiver is connected.
- Increase the separation between the equipment and receiver.
- Consult the dealer or an experienced radio/TV technician for help.

WARRANTY

Aiphone warrants its products to be free from defects of material and workmanship under normal use and service for a period of two years after delivery to the ultimate user and will repair free of charge or replace at no charge, should it become defective upon which examination shall disclose to be defective and under warranty. Aiphone reserves unto itself the sole right to make the final decision whether there is a defect in materials and/or workmanship; and whether or not the product is within the warranty.

This warranty shall not apply to any Aiphone product which has been subject to misuse, neglect, accident, or to use in violation of instructions furnished, nor extended to units which have been repaired or altered outside of the factory. This warranty does not cover batteries or damage caused by batteries used in connection with the product.

This warranty covers bench repairs only, and any repairs must be made at the shop or place designated in writing by Aiphone.

Aiphone will not be responsible for any costs incurred involving on site service calls.