

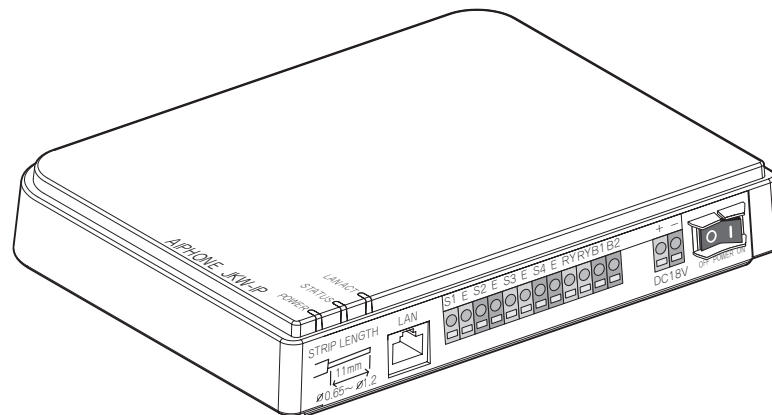

JKW-IP

IP Video Intercom Adaptor
Interface pour portier vidéo IP
IP-Adapter für JK-Videotürsprechanlage
Adaptador de intercomunicación por vídeo IP
IP adapter voor JK videofonie
Adattatore interfono video IP

INSTALLATION MANUAL
MANUEL D'INSTALLATION
INSTALLATIONSANLEITUNG
MANUAL DE INSTALACIÓN
INSTALLATIEHANDLEIDING
MANUALE D'INSTALLAZIONE



English	For safe and correct installation, be sure to read this installation manual carefully beforehand. Also read the Operation manual on the accompanying CD-ROM.
ATTENTION	Be sure to provide the customer with the CD-ROM which accompanies the unit.
Français	Afin de garantir une installation conforme, veuillez prendre connaissance de ce manuel d'installation au préalable. Veuillez également lire le manuel d'utilisation du CD-ROM qui accompagne chaque produit.
ATTENTION	Veillez à donner au client le CD-ROM qui accompagne l'appareil.
Deutsch	Zur sicheren und korrekten Installation lesen Sie bitte diese Installationsanleitung sorgfältig durch. Lesen Sie auch die Bedienungsanleitung auf der beiliegenden CD-ROM durch.
ACHTUNG	Stellen Sie sicher, dass die dem Gerät beiliegende CD-ROM dem Kunden geliefert wird.
Español	Para una instalación correcta y segura, asegúrese de leer detenidamente este manual de instalación. Lea también el manual de operación del CD-ROM de acompañamiento.
ATENCIÓN	Asegúrese de proporcionar al cliente el CD-ROM que acompaña a la unidad.
Nederlands	Lees deze installatiehandleiding zorgvuldig op voorhand voor een veilige en correcte installatie. Lees ook de gebruikshandleiding op de meegeleverde cd-rom.
OPGELET	Zorg ervoor dat u de klant steeds de cd-rom verschaft die bij het toestel geleverd wordt.
Italiano	Per eseguire un'installazione corretta e sicura, leggere innanzitutto questo manuale d'installazione. Leggere inoltre il Manuale d'uso contenuto nel CD-ROM in dotazione con ciascun prodotto.
AVVISO	Assicurarsi di fornire al cliente il CD-ROM in dotazione con l'unità.

PRECAUTIONS



Warning and Caution



General Prohibitions



Prohibition to Dismantle the Unit



Prohibition on Subjecting the Unit to Water



General Precautions

English

WARNING

Negligence could result in death or serious injury.

- ⊘ 1. Do not dismantle or alter the unit. Fire or electric shock could result.
- ⊘ 2. Keep the unit away from water or any other liquid. Fire or electric shock could result.
- ⊘ 3. High voltage is present internally. Do not open the case. Electric shock could result.
- ⊘ 4. Do not connect any non-specified power source to the +, - terminals. Also, do not install two power supplies in parallel to a single input. Fire or damage to the unit could result.
- ⊘ 5. Do not connect any terminal on the unit to an AC power line. Fire or electric shock could result.
- ⊘ 6. Do not use power supply with a voltage other than specified. Fire or electric shock could result.
- ⊘ 7. Do not put any metal or flammable material into the unit through the openings. Fire, electric shock, or unit trouble could result.

CAUTION

Negligence could result in injury to people or damage to property.

- ⊘ 1. Do not install or make any wire terminations while power supply is plugged in. It can cause electrical shock or damage to the unit.
- ❗ 2. When mounting the unit on a wall, install the unit in a convenient location, but not where it could be jarred or bumped. Injury could result.
- ❗ 3. Before turning on power, make sure wires are not crossed or shorted. If not, fire or electric shock could result.
- ⊘ 4. Do not install the unit in locations subject to frequent vibration or impact. It may fall or tip over and possibly damage the unit.
- ❗ 5. For power supply, use Aiphone power supply model or model specified for use with system. If non-specified product is used, fire or malfunction could result.
- ⊘ 6. Do not put anything on the unit or cover the unit with cloth, etc. Fire or unit trouble could result.
- ⊘ 7. Do not install the unit in any of the following locations. Fire, electric shock, or unit trouble could result.
 - * Places under direct sunlight or places near heating equipment that varies in temperature.
 - * Places subject to dust, oil, chemicals, etc.
 - * Places subject to moisture and humidity extremes, such as bathrooms, cellars, greenhouses, etc.
 - * Places where the temperature is quite low, such as inside a refrigerated area or in front of an air conditioner.
 - * Places subject to steam or smoke (near heating or cooking surfaces).
 - * Where noise generating devices such as dimmer switches or inverter electrical appliances are close by.

General Precautions

- 1. Keep the unit more than 1 m away from radio or TV set.
- 2. Keep the intercom wires at least 30 cm (12") away from AC 100-240 V lines. Noise and malfunction could result.
- 3. Install the unit in an area that will be accessible for future inspections, repairs, and maintenance.
- 4. As to other manufacturer's devices (such as sensor, detectors, door releases) used with this system, comply with the Specifications and Warranty conditions that the manufacturers or vendors present.
- 5. This unit is for indoor use only. Do not use outdoors.
- 6. If the unit is down or does not operate properly, unplug the power supply or turn off the POWER switches.
- 7. When wall-mounted, the top of the unit may darken. This does not indicate a malfunction.
- 8. The unit case may become warm with use, but this is not a unit malfunction.
- 9. If it is used close to a cellular phone, the unit may malfunction.
- 10. The unit can be damaged if dropped. Handle with care.
- 11. The unit turns inoperative during power failure.
- 12. In areas where broadcasting station antennas are close by, the intercom system may be affected by radio frequency interference.

PACKAGE CONTENTS

JKW-IP



Wood mounting screws × 2
(ø4 × 16 mm)



“OPERATION MANUAL & Software” (CD-ROM) X 1
Installation Manual (this document)×1
Chinese ROHS (single sheet)×1

Spacers × 2



NAMES

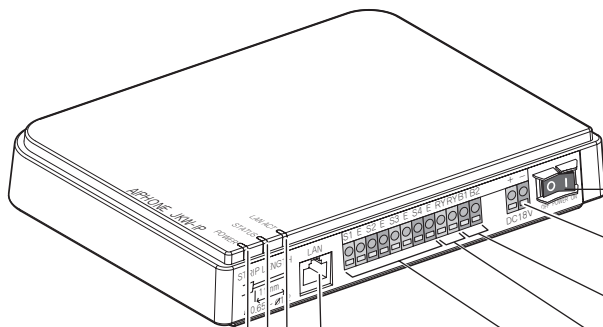

LAN port

Connects networking unit such as router.

LAN ACT indicator (Orange)

Lit orange when a LAN is connected, and blinks while exchanging information over the Ethernet.

STATUS indicator (Orange)

Blinks orange while the system starts up, and remains lit once startup is complete.

POWER indicator (Green)

Lit green when the power is on.

POWER switch

Turns the power ON or OFF.

POWER terminal (18V DC)

Connects the power cable.

Master monitor station connection terminal

Connects to the master monitor station.

Option output terminal

Connects output signals for option unit.

Sensor input 1~4 terminals

Connects to buttons, sensors, etc. for option unit.

< Back view >

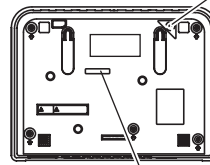

Default setting switch (within the sticker area)

Never press the default setting switch unless it is necessary. The registered settings will return to the factory (default) settings.

MAC Address
(Do not remove)

WIRING DISTANCE

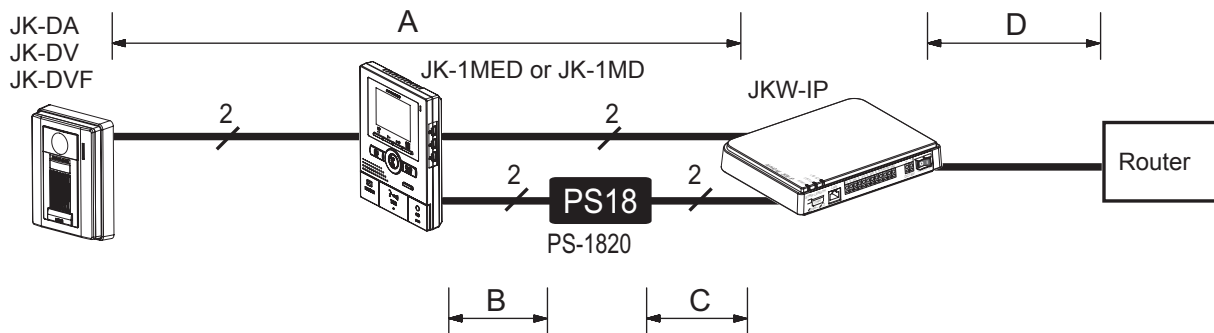

	Ø0.65 mm	22AWG	Ø1.0 mm	18AWG	CAT5e/6
A	50 m	165'	100 m	330'	—
B	5 m	16'	10 m	33'	—
C	50 m	165'	100 m	330'	—
D	—	—	—	—	100 m, 330'

CABLE

1 Use PVC jacket with PE (polyethylene) insulated cable.



3 When using a cable with unused conductors, terminate both ends of the unused pair(s) with a 120 Ω resistor.

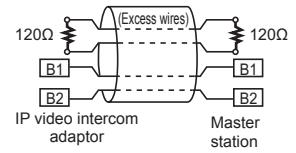

2 Never use individual conductors, twisted pair cable or coaxial cable.

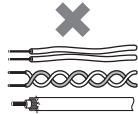

4 Odd number cables, such as three conductor wire, cannot be used.



English

●About LAN cables

- When installing LAN cables, do not bend them to an extent where the radius is 30 mm (1-3/16") or less. Communication failure could result.



- Do not remove more of the LAN cable jacket than necessary.
- Arrange the color code of the RJ45 connections in accordance with EIA/TIA-568A and 568B.

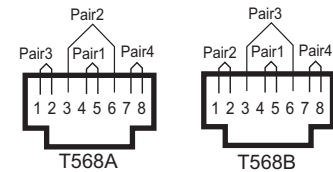

MOUNTING

Install the unit on a shelf or wall in an area that will be accessible for future inspections, repairs, and maintenance.

Be sure to install the unit so that each indicator can be checked.

● When installing the unit on the wall

1 Attach spacers to the wood mounting screws, and then attach them to the wall.

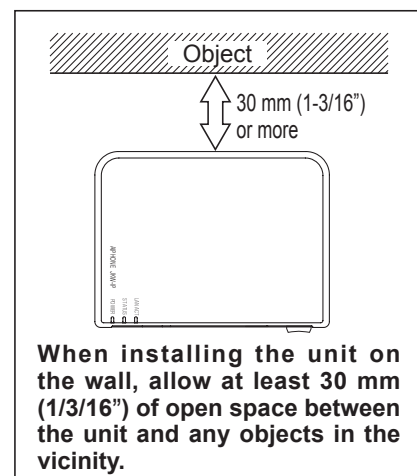
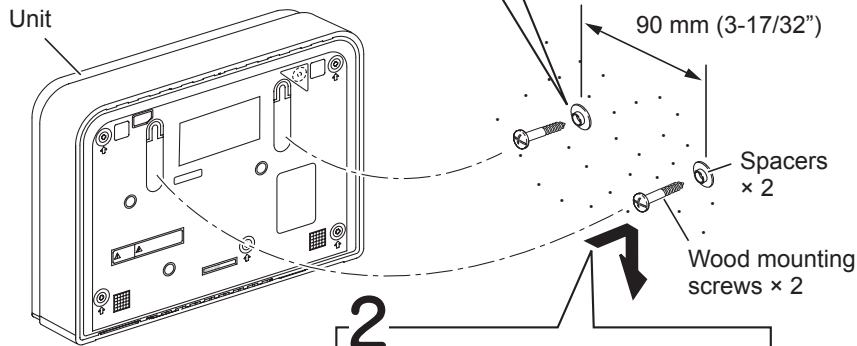

Size of the gap between the screws for installing the unit on the wall

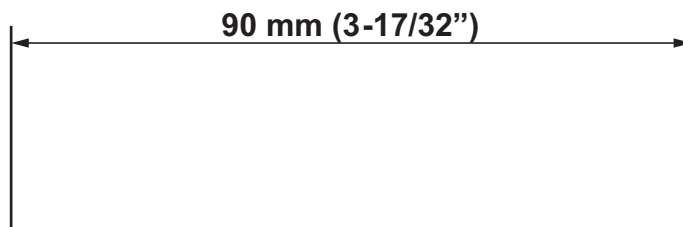

WIRING

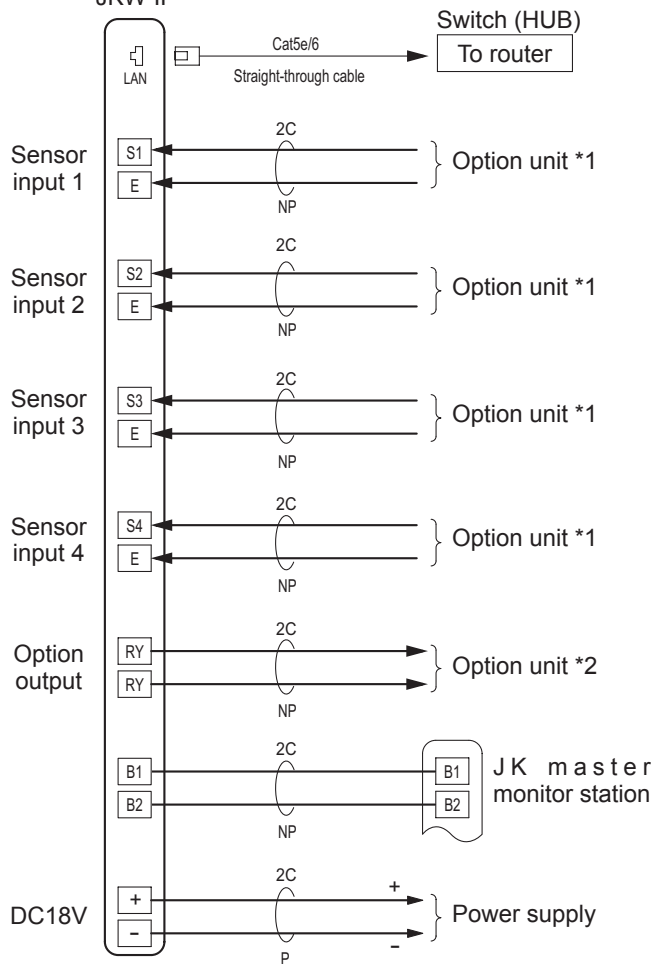

NP : Non-polarized
P : Polarized



• Do not use the unmarked terminals for other purposes.
• For the connection of products manufactured by other companies, refer to the manuals which accompany them.

*1. Input specifications

Input method	N/O or N/C dry closure contact (start signal only detection method)
Detection confirmation time	100 mS or more
Contact resistance	During N/O dry closure: Less than 700 Ω During N/C dry closure: At least 3 k Ω
Terminal short current	Less than 10 mA
Voltage between terminals	Less than 20 V DC (when open between terminals)

*2. Output specifications

Output method	N/O dry closure contact
Voltage between terminals	24V AC, 0.5A (resistive load) 24V DC, 0.5A (resistive load) Minimum overload: 100mV DC, 0.1mA

PS-1820



● Connection of stranded wires

Twist the strands together, then insert the wire into one of the quick coupling terminals.



11 mm
(7/16")

Recommended wire diameter: 1.0 mm (18AWG)

To ensure that the wire won't bend, press the release button while inserting into terminal.

SETTING UP

First, install the supplied software onto your PC in order to set up and use this unit.

Follow the operation manual located in each language folder of the accompanying CD-ROM to install and set up the software.

OPERATION MANUAL & Software (CD-ROM)

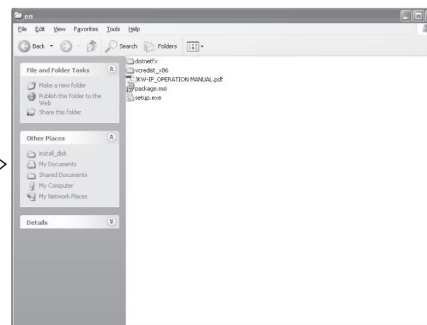
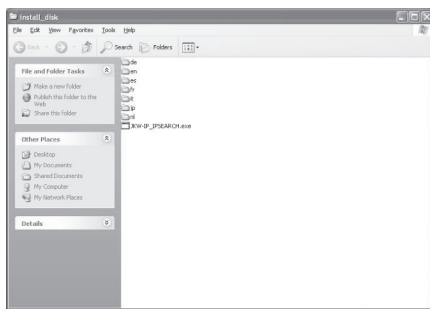
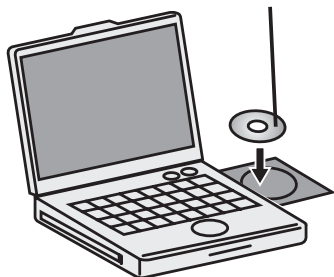

de : German
en : English
es : Spanish

fr : French
it : Italian
jp : Japanese

nl : Dutch

English

■ This document has been carefully compiled. Should you have questions, find an error, or find that information is missing, please contact your distributor or the nearest regional office.

The above provisions notwithstanding, we will under no conditions be liable for any damages or losses resulting from use of this product.

■ If you use this product for applications that require extreme reliability, please take thorough and appropriate measures to ensure the safety of the intended system and to safeguard against possible failures.

■ Specifications, design, and other aspects of the product indicated in this document are subject to change without notice to allow for improvements.

■ The names of products of other firms referenced in this document are the trademarks or registered trademarks of the respective companies.

Such product names are not explicitly indicated by the symbols "TM", "®", or "©".

Français

Deutsch

Español

Nederlands

Italiano

■ Ce document a été établi avec attention. Pour toute question, en cas d'erreur ou d'information manquante, veuillez contactez votre distributeur ou le bureau régional le plus proche.

A l'exception des mentions précédentes, nous ne serons en aucune circonstance responsables des dommages ou pertes causées par l'utilisation de ce produit.

■ Si vous utilisez ce produit pour des applications nécessitant une très grande fiabilité, veuillez prendre toutes les mesures appropriées afin de garantir la sécurité du système envisagé et de vous prémunir contre les pannes possibles.

■ Les spécifications, la conception et les autres aspects du produit mentionnés dans ce document sont susceptibles d'être modifiés sans préavis, afin d'en permettre l'amélioration.

■ Les noms des produits d'autres sociétés mentionnés dans le présent document sont les marques ou les marques déposées de ces mêmes sociétés.

Les noms de ces produits ne sont pas explicitement désignés par les symboles « TM », « R » ou « C ».

■ Dieses Dokument wurde mit Sorgfalt erstellt. Wenn Sie Fragen haben, einen Fehler finden oder Ihrer Meinung nach Informationen fehlen, wenden Sie sich bitte an Ihren Händler oder die nächste regionale AIPHONE-Vertretung.

Ungeachtet der obenstehenden Angaben haften wir für keinerlei Schäden oder Verluste, die aufgrund des Gebrauchs dieses Produkts entstehen.

■ Bei Gebrauch dieses Produkts für Anwendungen, die extreme Sicherheit erfordern, ergreifen Sie bitte sorgfältige und angemessene Maßnahmen, um die Sicherheit des vorgesehenen Systems zu gewährleisten und gegen mögliche Störungen zu schützen.

■ Technische Daten, Design und andere Aspekte des Produkts, die in diesem Dokument dargestellt werden, können jederzeit ohne Ankündigung zum Zwecke der Verbesserung geändert werden.

■ Die Namen von Produkten anderer Hersteller, die in diesem Dokument genannt werden, sind Warenzeichen oder eingetragene Warenzeichen der jeweiligen Unternehmen.

Derartige Produktnamen werden nicht ausdrücklich mit den Symbolen "TM", "R" oder "C" versehen.



AIPHONE®
Providing Peace of Mind
<http://www.aiphone.net/>

AIPHONE CO., LTD., NAGOYA, JAPAN
AIPHONE CORPORATION, BELLEVUE, WA, USA
AIPHONE S.A.S., LISSES-EVRY, FRANCE
Printed in Japan