

*NEM/C Series*  
**LAMP MEMORY INTERCOM**

Models: **NEM-10/C, NEM-10A/C:** 10-call master  
**NEM-20/C, NEM-20A/C:** 20-call master  
**NEM-30/C, NEM-30A/C:** 30-call master  
**NEM-40/C, NEM-40A/C:** 40-call master \* NEM-nA/C: w/handset

**INSTALLATION & OPERATION MANUAL**

This Manual and the Markings on the product contain various symbols in order that the product can be used safely and properly, and that the installer and user are protected from injury and property damage. The following precautions must be thoroughly read and understood before proceeding.

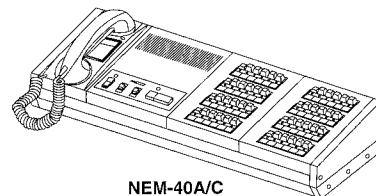











**PRECAUTIONS ON INSTALLATION & WIRING**



 **WARNING** *Negligence could result in death or serious injury.*



 **CAUTION** *Negligence could result in injury or damage to property.*

 **WARNING**

1. Do not connect any power source other than specified on NEM master. Fire or damage to the unit could result. 
2. Do not open NEM master. High voltage is present inside, and it can cause electric shock. 
3. Do not change or alter NEM master. It can cause fire or electric shock. 
4. Make sure wires are connected properly before plugging in power supply. 
5. Keep NEM master away from water or any other liquid. Fire or electric shock could result. 
6. Keep AC plug away from moisture or dust. 
7. Keep AC cord away from being marred or crushed. 
8. Do not plug or unplug with wet hands. 
9. Do not put any metal into NEM through openings. It can cause fire, electric shock or unit damage.  

 **CAUTION**



1. Do not make call tone testing with hook switch manually held down. The call tone sounds very loud near your ears, and can cause your hearing damage. 
2. Do not install or make any wire terminations while power supply is plugged in. It can cause electrical shock or damage to the unit. 



3. Install NEM master in a convenient location, but not where it could be bumped or jarred. 
4. In case of electrical storms, unplug power supply from AC outlet. It can cause fire, electric shock, or power surge damage.
5. Do not install NEM components in any of the following locations, as it may cause the system to malfunction;
  - **High or extreme cold temperature area:** under direct sunlight, near equipment that varies in temperature, in front of air conditioner, inside a refrigerated area, etc.
  - **Places subject to moisture or humidity extremes.** 
  - **Places subject to environmental conditions,** such as oil, dust, chemicals, salt, etc.
  - **Places subject to constant vibration or impact.**
  - **Places where noise generating devices such as TV or radio are close by.**



 **GENERAL PRECAUTIONS**

1. NEM equipment is designed for indoor use only. Do not install outdoors.
2. NEM system is not operational during a power failure.
3. In areas where broadcasting station antennas are close by, intercom system may be affected by radio frequency interference.
4. Keep all DC wiring at least 30cm, 1' away from AC 100-240V wiring, fluorescent lighting, or dimmer switches. Otherwise, cross AC wiring at a 90° angle.

**Examples of Symbols;**

 **GENERAL PRECAUTIONS**  
The  mark indicates caution statement (incl. danger and warning), which is specifically shown inside.

 **GENERAL INSTRUCTIONS**  
The  mark indicates contents which demands a specific action shown inside or attached.

 **GENERAL PROHIBITIONS**  
The  mark indicates contents which prohibit a specific action shown inside or attached.

 **DISMANTLE PROHIBITIONS**

 **MOISTURE PROHIBITIONS**

# 1 SYSTEM OUTLINE & COMPONENTS

The NEM-n/C & NEM-nA/C are master stations of Lamp Memory Intercom for 10 to max. 40 sub stations. NEM master station is capable of carrying out communication by either open voice press-to-talk or lifting handset operation, as well as transmit all call to all the sub stations simultaneously.

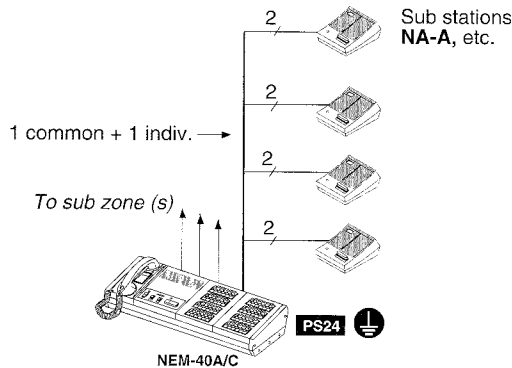

Note: For more than 40 to max. 120-station system, SOP (\*) master stations are available; NEM-50 ~ 120, NEM-50A ~ 120A (7.7.A for CE).

## PACKAGE CONTENTS

- Master station **NEM-n/C**, **NEM-nA/C** ( $n = 10, 20, 30$  &  $40$ )
- Mounting hardware
- Installation & Operation Manual

**PS24** : 24V DC power supply  
**PS-2410A** (in USA, 10 ~ 20-call)  
**PS-24ME** (in Europe, 10 ~ 20-call)  
**PS-24E** (10 ~ 40-call)

⚠ To avoid noise interference, be sure to take G terminal on PS-24E to earth.

## COMPONENTS AVAILABLE

- Press-to-talk master station
- Master station w/handset

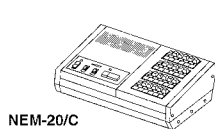

NEM-20/C

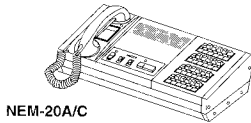

NEM-20A/C

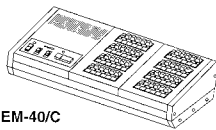

NEM-40/C

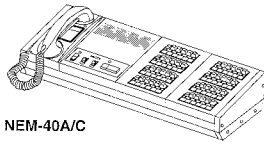

NEM-40A/C

**NEM-10/C**: 10-call master  
**NEM-20/C**: 20-call master  
**NEM-30/C**: 30-call master  
**NEM-40/C**: 40-call master

**NEM-10A/C**: 10-call master  
**NEM-20A/C**: 20-call master  
**NEM-30A/C**: 30-call master  
**NEM-40A/C**: 40-call master

- 24V DC power supply

For up to 20 subs

**PS-2410A**: 1A (120V AC)  
**PS-24ME**: 0.9A (220V AC)  
**PS-24E**: 2A (110V ~ 120V,  
 220V ~ 240V AC)

For 21 ~ 40 subs

**PS-24E**: 2A (110V ~ 120V,  
 220V ~ 240V AC)

- Sub stations

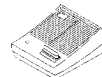

NA-A



NA-AN



NA-NE



NB-L

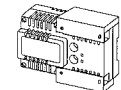

PS-24ME

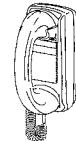

NA-T/A

**NA-A**: Desk/wal, single-gang  
**NA-AN**: w/PRIV. button  
**NA-NE**: Flush aluminum panel  
**NB-L**: Ceiling mount  
**NA-T/A**: Handset sub, single-gang

## System options

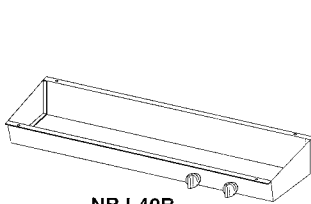

NBJ-40B



IER-2



NB-U

**IER-2**: Call extension speaker (at NEM)  
**NB-U**: Music adaptor. One per 40 subs. Requires music source & amplifier.  
**NEW-5**: Dual-call adaptor. One per 5 subs. Requires 12V DC power supply  
**NBJ-20**: Call switching device for NEM-10/C & 20/C  
**NBJ-40**: for NEM-30/C & 40/C  
**NBJ-20B**: for NEM-10A/C & 20A/C  
**NBJ-40B**: for NEM-30A/C & 40A/C

## Health Care accessories

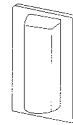

NBY-4A



NAR-6A, black



NBY-1A



NAR-3

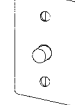

NAR-2A, white

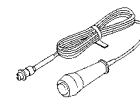

NBR-8A

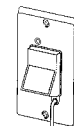

NBR-7AS

**NBY-4A**: Corridor call light, single-gang (for up to 3 subs) same (for 4 to max.8 subs) (SOP) [→ See P.10]  
**NR-4AS13**: same (for use in a patient room) (SOP) [→ See P.8]  
**NAR-3**: Round bracket  
**NAR-6A**: Flush call button plate, single-gang  
**NBY-1A**: Flush metal jack plate, single-gang  
**NBR-8A**: Bedside manual call switch  
**NBR-7AS**: Moisture resistant pullcord, single-gang  
**NBR-7AS-S**: same (for use in a patient room) (SOP) [→ See P.8]

\* NAR-3: Not available in USA  
 NR-4AS13, NBR-7AS-S: Not available in Europe  
 SOP (Special Order Product)

## 2 NAMES & FEATURES

NEM-40A/C

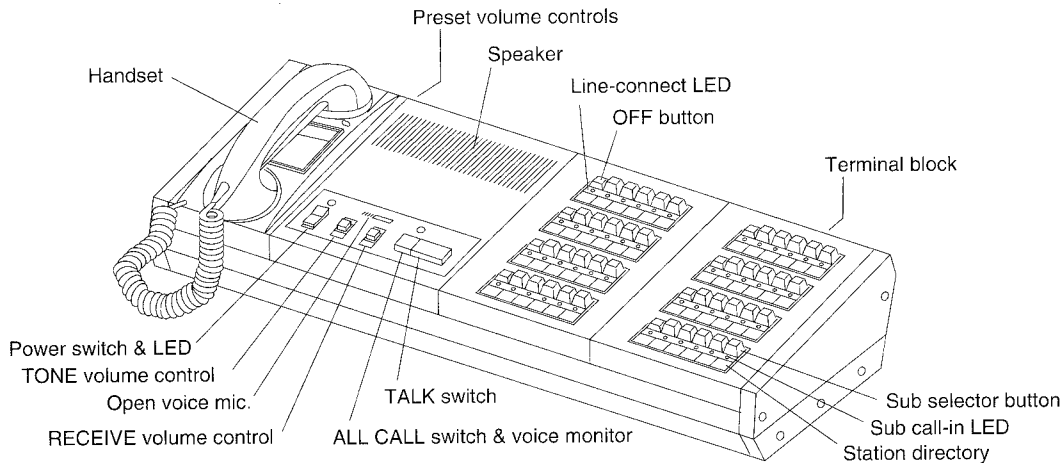

<b>Handset</b>	Used for private communication (voice-actuation)
<b>Power switch &amp; LED</b>	Keep powered status, otherwise calling becomes inoperational
<b>TONE volume control</b>	Adjusts sub's call-in tone in 3 positions
<b>Open voice mic.</b>	Mic. is on in open voice mode
<b>RECEIVE volume control</b>	Adjusts receive volume in 3 positions
<b>TALK switch</b>	Used for open voice communication with NA sub or all call for max. 10 selected NA subs
<b>ALL CALL switch &amp; voice monitor</b>	Instantly, activates all sub station speakers. Hold down to transmit.
<b>Station directory</b>	Fill in name by oil-soluble pen
<b>Sub call-in LED</b>	Upon CALL button pushed at sub, LED is steadily lit to indicate, sounding audible tone
<b>Sub selector button</b>	In both initiating and receiving a call, depress a button to establish the channel
<b>Preset volume controls</b>	Preadjusts volumes of all call, transmit, receive & tone.
<b>Speaker</b>	Call tone rings, and hears sub's voice
<b>Line-connect LED</b>	Lit during communication
<b>OFF button</b>	Disconnects a channel of sub, and puts system in standby
<b>Terminal block</b>	Wires all sub station speakers and optional accessories

### FEATURES

- 10 to 40-station call systems
- Handset auto voice actuation and/or press-to-talk communication
- Tone & LED call-in, staying until master answers
- Built-in All Call
- Multiple subs call, selectively up to 10 subs
- Pre-tone at sub as attention-getter upon selected
- Minimized crosstalk, and secured voice volume
- Two conductor per sub, home run or multi-conductor cable run
- Call extension speaker IER-2
- Accessories for health care applications
- Music distribution through sub stations. Requires NB-U adaptor, 10W amp. & music source
- Call switching device to route any sub call-in to the NEM master station on duty
- Sub station can call dual NEM masters simultaneously

# 3 NAMES & FUNCTIONS

## Sub stations

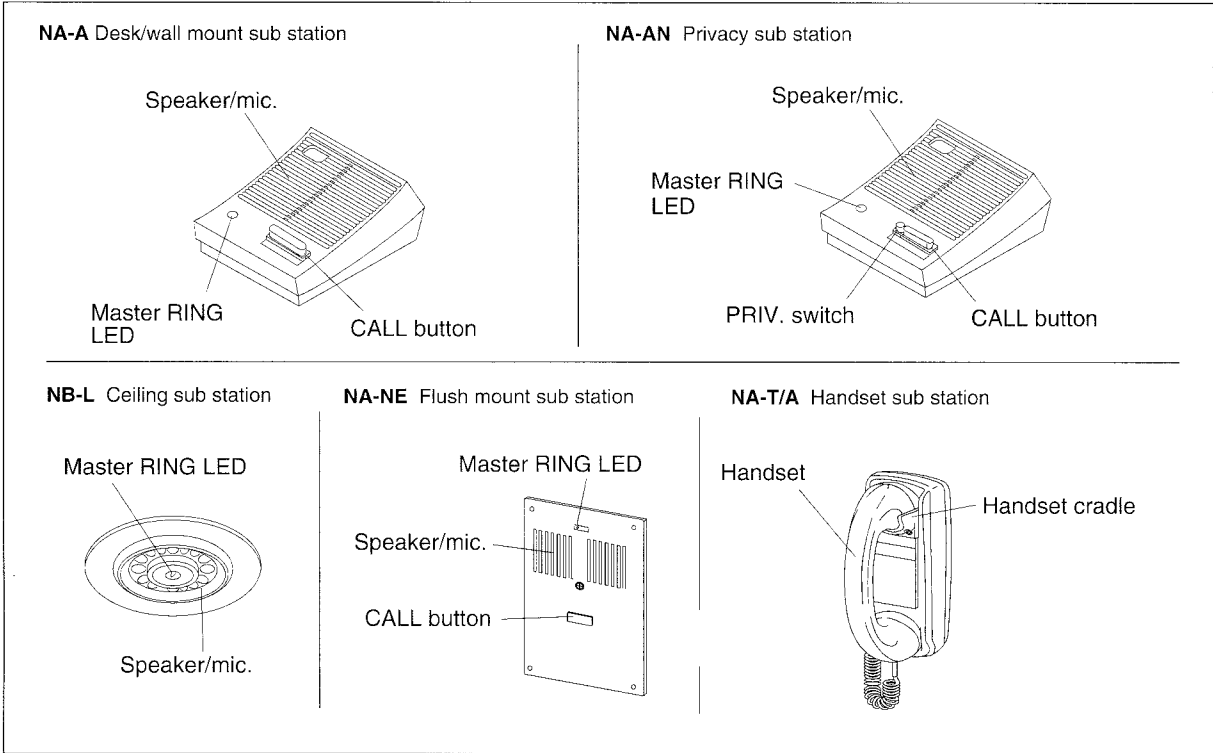

## Accessories

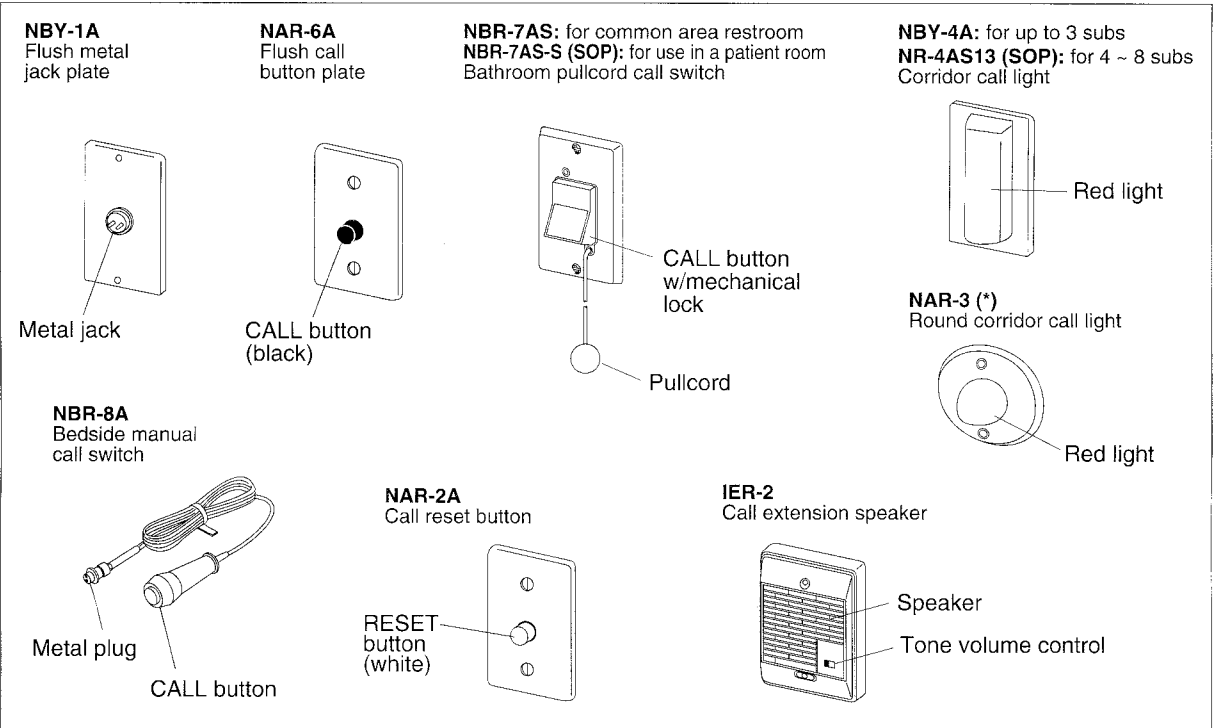

(\*) NAR-3: Not available in USA  
NR-4AS13, NBR-7AS-S (SOP): Not available in Europe

# 4 INSTALLATION

## SYSTEM COMPOSITION

The NEM-n/C & NEM-n/A/C can be composed into the following systems with the optional accessories.

NEM intercom communication	System consists of NEM master and sub stations as needed.
Health care communication	Each sub station is connected with a corridor call light & reset button. Ceiling sub NB-L is combined with bedside call switch.
Call switching device	Any sub's call-in received by one NEM, can be rotated to the other NEM on duty.
Dual master call	NEW-5 adaptor enables up to 5 sub stations to ring two NEM's simultaneously. Install multiply NEW-5's with a 12V DC power supply.
Music distribution to NA subs	NB-U adaptor distributes background music to NA subs in conjunction with music source & an appropriate amplifier.

## COMMUNICATION

After depressing a sub selector button, depress TALK switch to transmit or release to listen. On NEM-A/C only, lift handset and communication will be automatic activation. Speak into the handset, and NEM transmits voice. Quit speaking, and NEM turns to receive mode.

## STATION SELECTION

1. Sub station: NA-T/A handset can be used alone or attached the other sub station.
2. NEW-5 dual call adaptor is not useable with in NB-U used system.

## POWER SUPPLY

Master stations	Power supply
NEM-10/C, NEM-20/C NEM-10A/C, NEM-20A/C	<b>PS-2410A</b> (24V DC, 1A) <b>PS-24ME</b> (24V DC, 0.9A) <b>PS-24E</b> (24V DC, 2A)
NEM-30/C, NEM-40/C NEM-30A/C, NEM-40A/C	<b>PS-24E</b> (24V DC, 2A)

**⚠ Do not connect two power supplies in parallel.**

## WIRING METHODS

Lay out your NEM system in advance. Determine the locations of each NA sub station and wire to each. Two conductors are required per sub station.

1. Two wires from each sub station to NEM terminal block.
2. Two wires from each sub to a local junction box, then multi-conductor cable to NEM terminal block.
3. Use a multi-conductor cable looped through each sub.

**IMPORTANT:** When a multi-conductor cable is not used, be sure to run each cable **in the same conduit**, in order to make each sub station line as near the common line as possible.

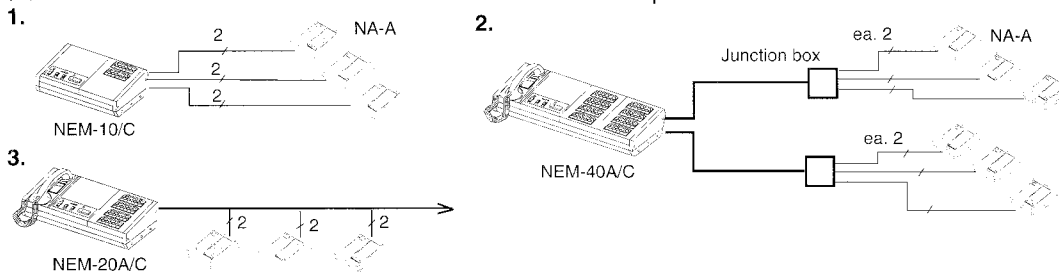

## MOUNTING LOCATIONS

1. Select a mounting location which meets the following criteria:
  - is free from dust, vibration,
  - is not near heating or air conditioning equipment,
  - does not have temperature/humidity extremes,
  - run in not bare wires on floor subject to be pinched by furniture, etc.,
  - is not near inflammable or chemical products.

**NONE OF THE SYSTEM COMPONENTS IS EXPLOSION-PROOF TYPE.**
2. NBR-7AS bathroom pullcord is moisture-resistant, but not water-resistant. Avoid such location as near bathtub, etc. where it could receive shower directly.
3. NA-NE is not weather-resistant. Do not install outdoors.

# TERMINAL IDENTIFICATIONS

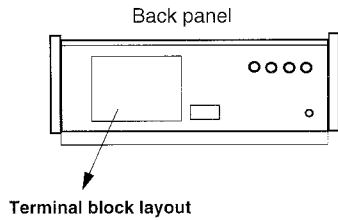

1 ~ 40 : Connect to sub station  
**E**  
 (\*1) **S, S** (or **S, E**) : Connect to IER-2 call extension  
**Q, H, Y, E** : Connect to NEW-5 adaptor  
**X1 ~ X8** : Unused (for add-on selector)

(\*2) **B, Y** : Connect to NB-U adaptor  
**V1 ~ V4**  
**A1 ~ A4**

**+**, **-** : Power supply (24V DC)

(\*1) S, E: in NEM-10, 20(A)/C  
 (\*2) B, Y: same terminal

NEM-10/C, NEM-20/C  
 NEM-10A/C, NEM-20A/C

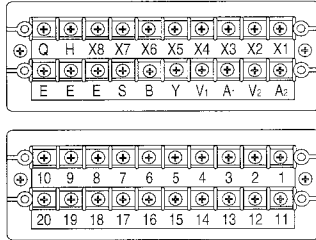

NEM-30/C, NEM-40/C  
 NEM-30A/C, NEM-40A/C

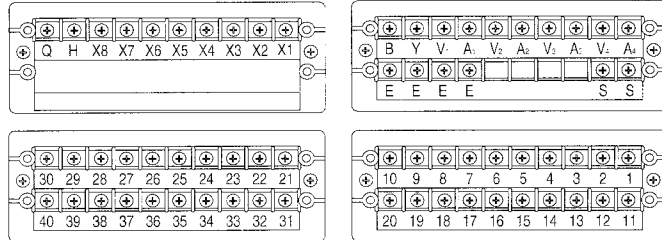

## SUB STATION TERMINAL & WIRE IDENTIFICATIONS

NA-A or NA-AN

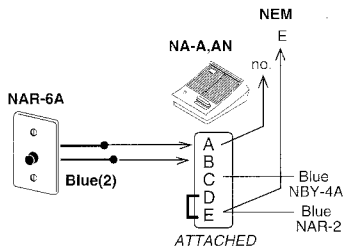

**Add call button**  
 Connect two blue wires to A, B on NA-A, AN.

**When corridor call light is installed**  
 Remove a jumper D - E on NA-A, AN.

NA-NE

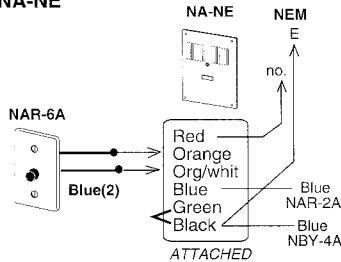

**Add call button**  
 Connect two blue wires to Orange, Org/whit wires on NA-NE.

**When corridor call light is installed**  
 Remove a jumper GREEN BLACK on NA-NE.

NB-L

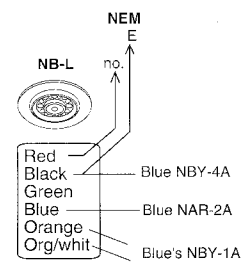

**When corridor call light is installed**  
 Cut out a jumper GREEN on NB-L.

NA-T/A

NA-T/A sub station receives a pre-tone and voice transmission from NEM master station. For full 2-way communication, lift NA-T/A handset. When NA- open voice sub station is combined, NA-T/A handset disables the NA sub station.

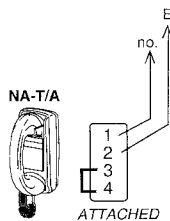

Adding NA-T/A handset to NA sub station

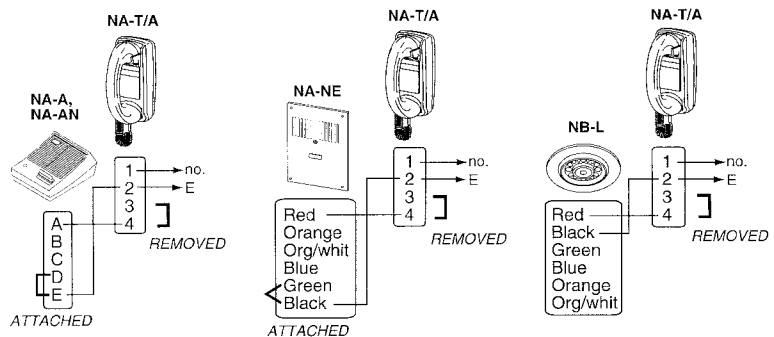

# 5 WIRING DIAGRAMS

## Basic master to sub system

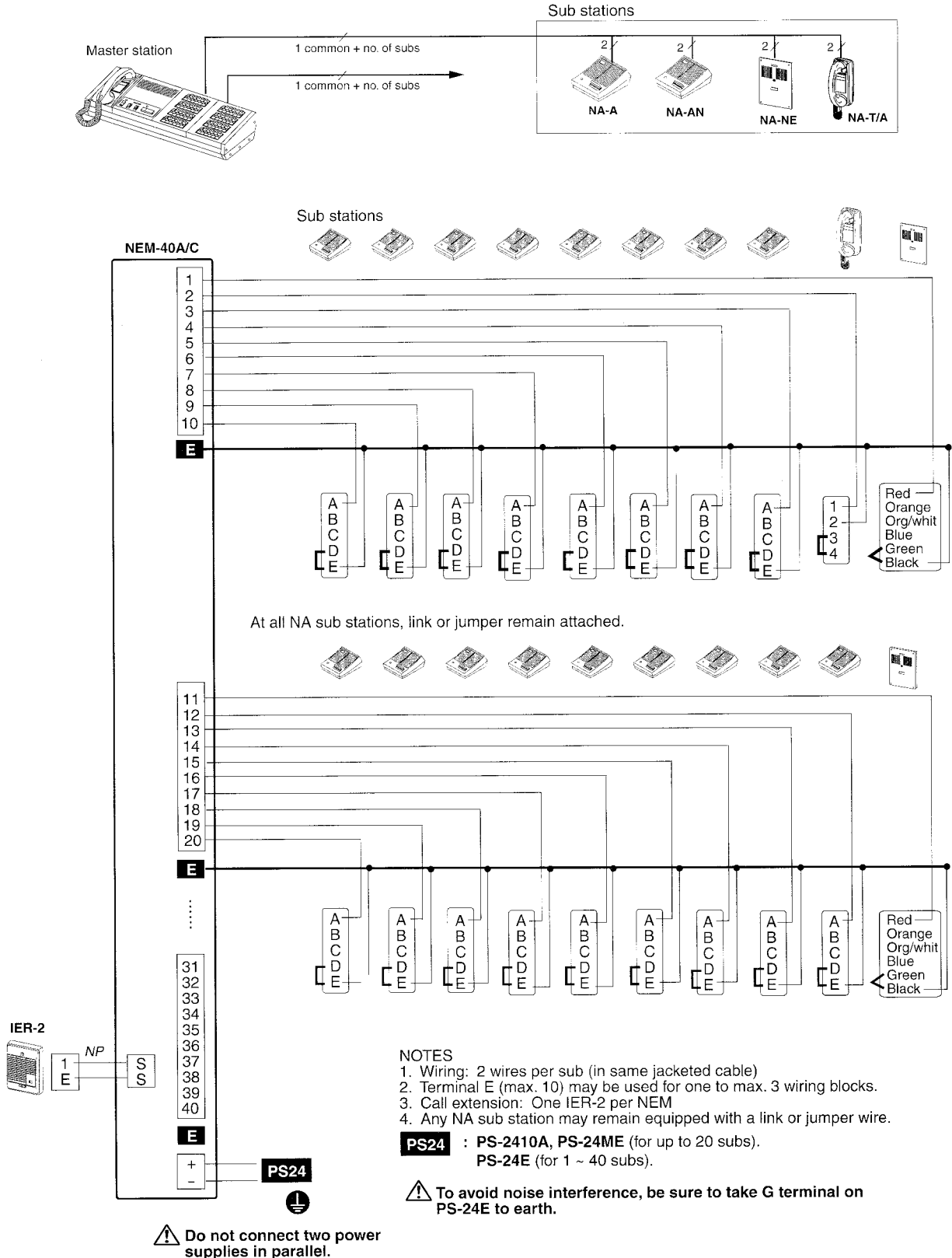

# 5 WIRING DIAGRAMS (continued)

## Health care applications

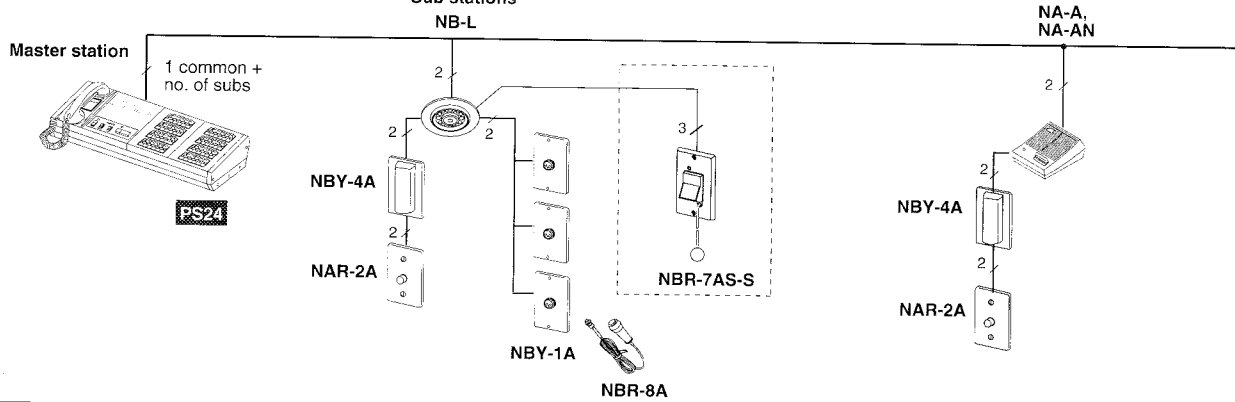

## NEM-40A/C

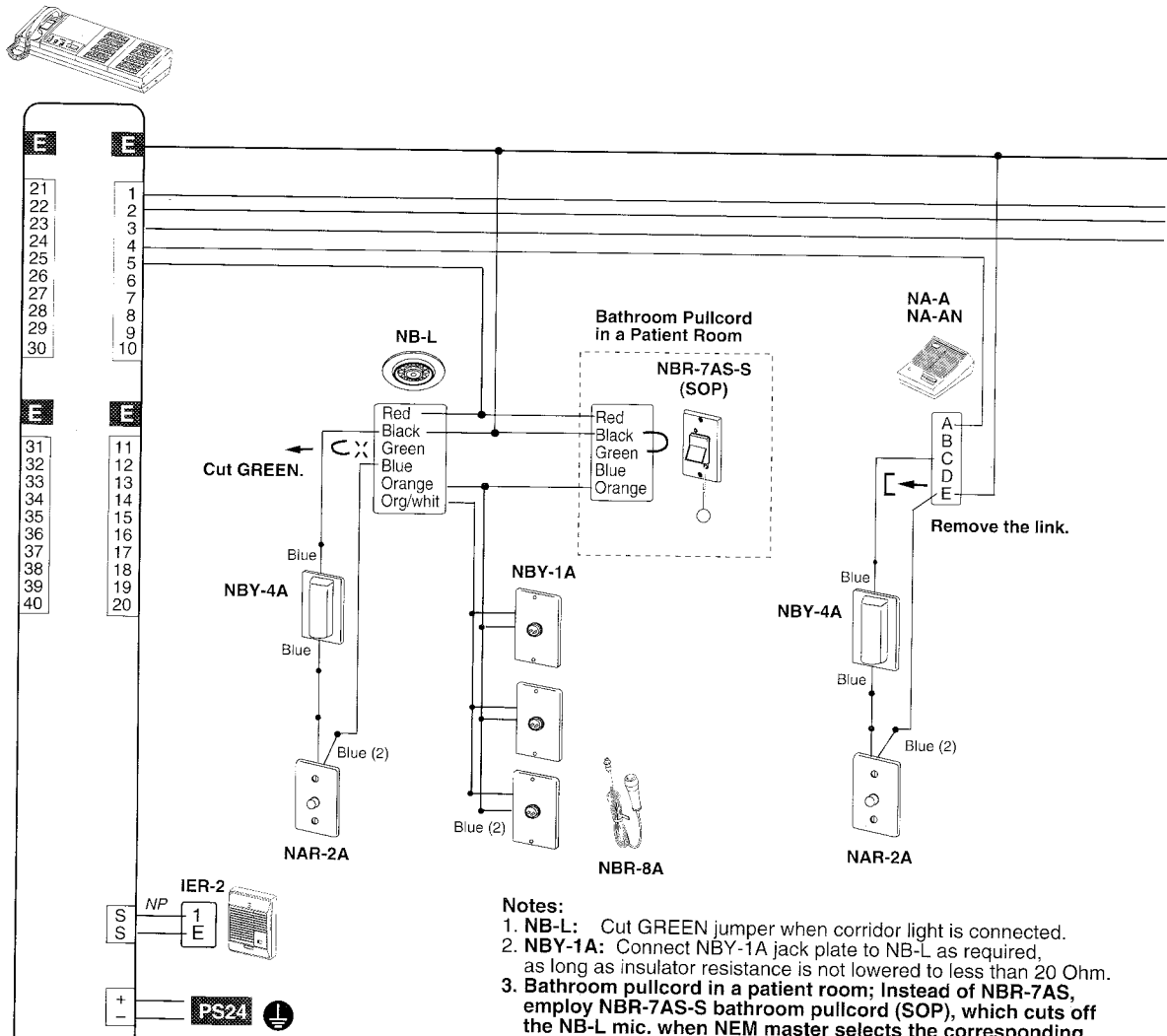

### Notes:

1. NB-L: Cut GREEN jumper when corridor light is connected.
2. NBY-1A: Connect NBY-1A jack plate to NB-L as required, as long as insulator resistance is not lowered to less than 20 Ohm.
3. Bathroom pullcord in a patient room; Instead of NBR-7AS, employ NBR-7AS-S bathroom pullcord (SOP), which cuts off the NB-L mic. when NEM master selects the corresponding selector button.  
Up to three NBR-7AS-S can be connected, paralleling each BLACK, RED & ORANGE wires. Call-in from NBR-7AS-S cannot be cancelled with NAR-2A Call reset button. Go to the calling site, and press on upper end of Call button on NBR-7AS-S to release the call.

**PS24**: PS-2410A, PS-24ME (for up to 20 subs).  
PS-24E (for 1 ~ 40 subs).

⚠ To avoid noise interference, be sure to take negative (-) terminal on PS-24E to earth ground.



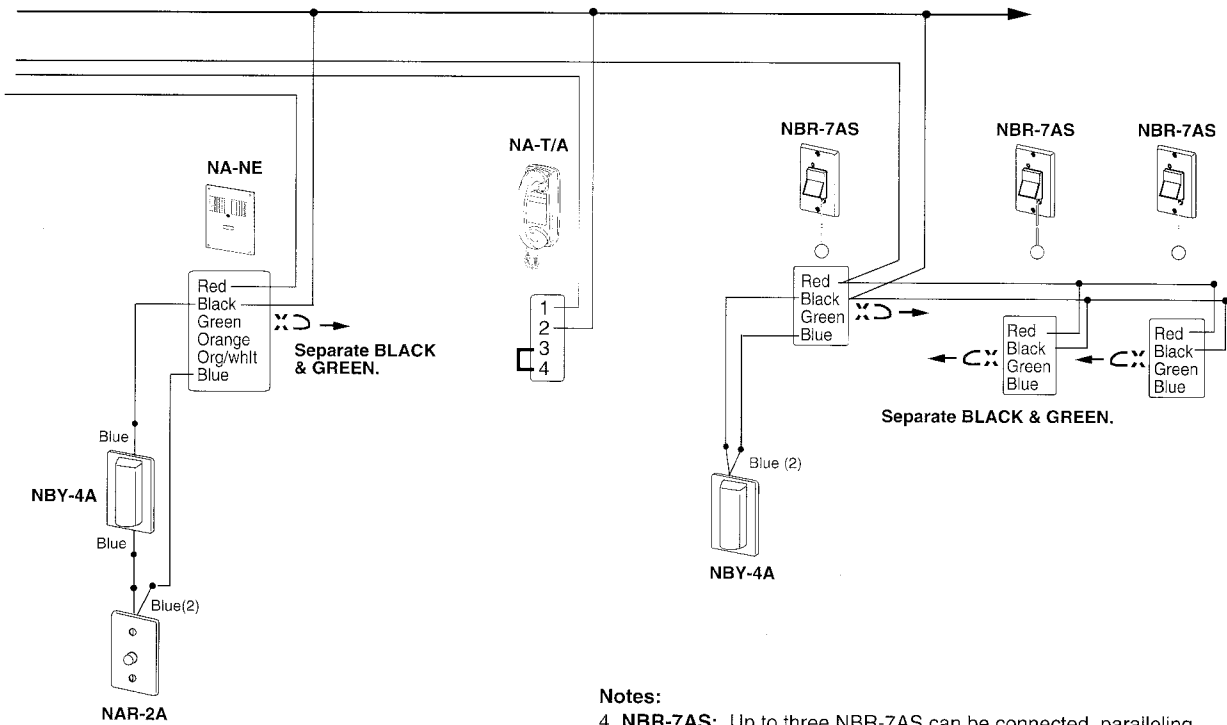
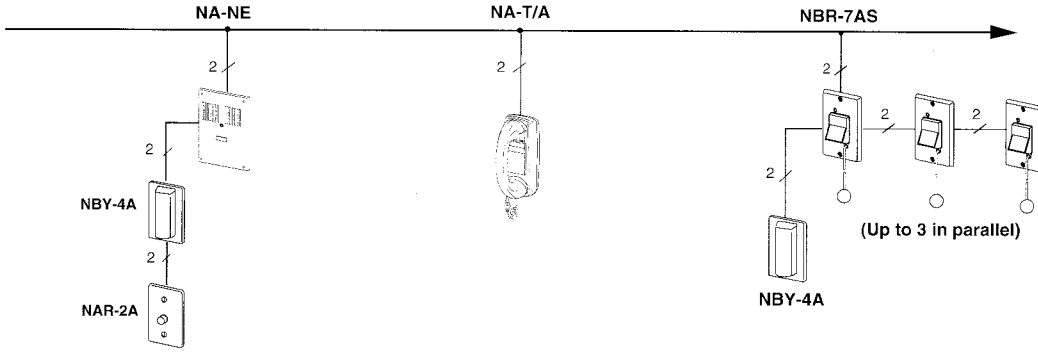

**Notes:**

4. **NBR-7AS:** Up to three NBR-7AS can be connected, paralleling each BLACK, RED & BLUE wires. (Separate BLACK & GREEN).
5. **NR-4AS13:** When 4 to 8 NBR-7AS are used, employ NR-4AS13 for corridor call light.

# 5 WIRING DIAGRAMS (continued)

## Multiple sub stations in a patient room

Max. 8 NA sub stations can be installed within a patient room. For corridor call light, use NBY-4A for up to 3 subs, and NR-4AS13 (SOP) for 4 to max. 8 subs. Selector number must be applied to individual sub stations.

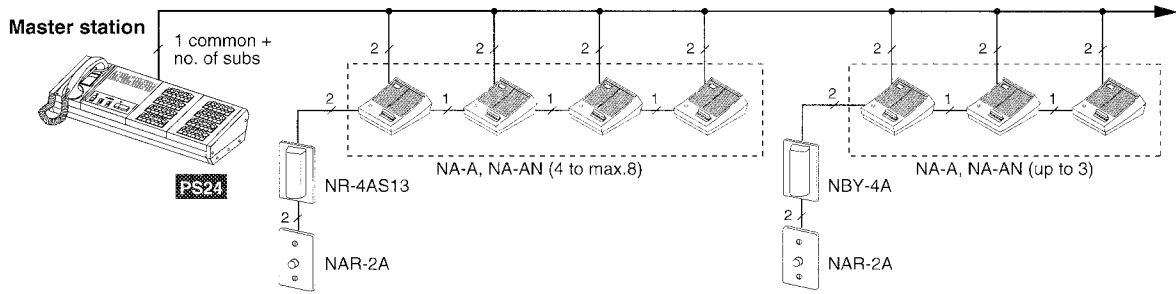

\* Install NR-4AS13 (SOP) for 4 to max. 8 subs.

\* Install NBY-4A for 1 to max. 3 subs.

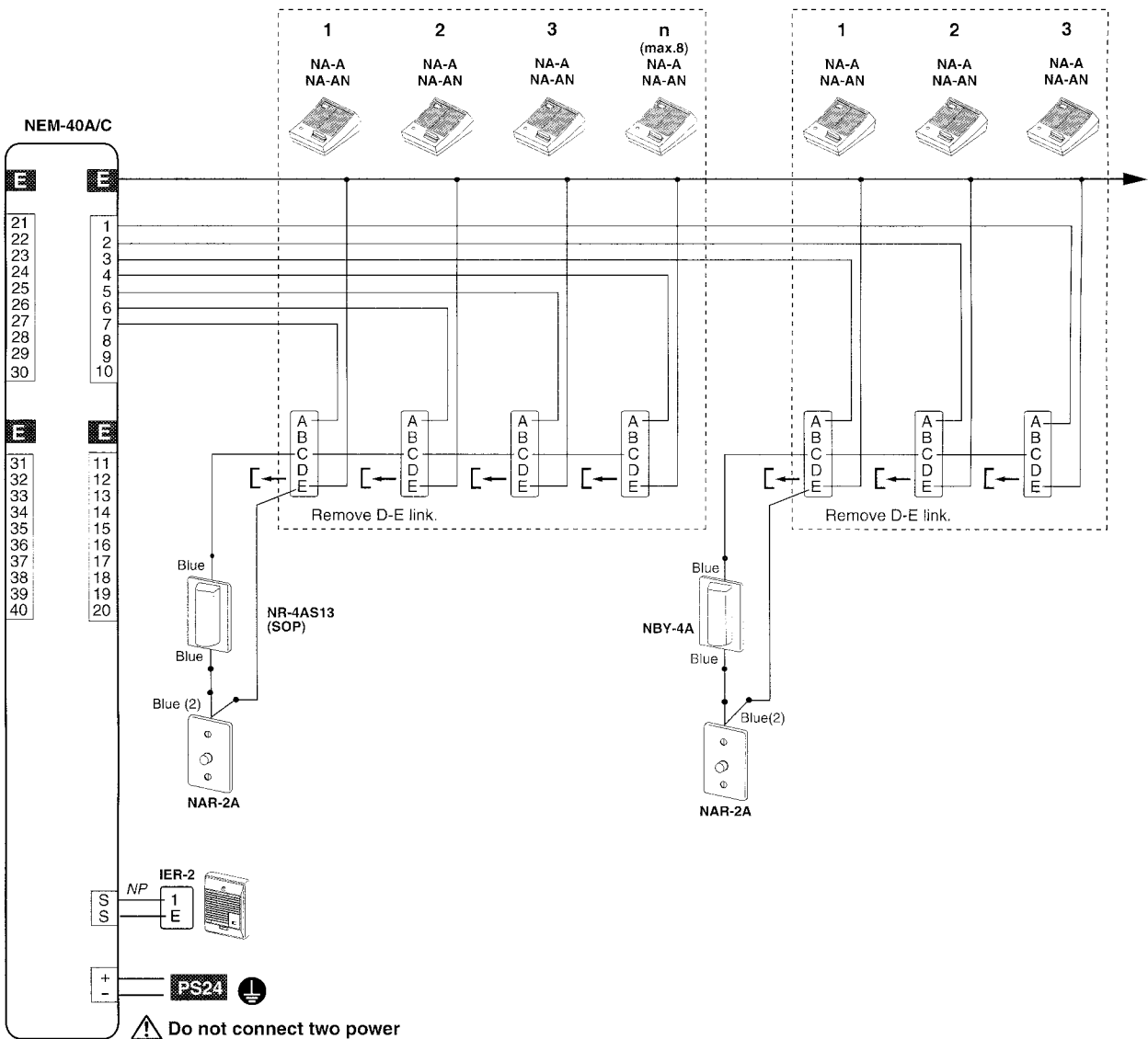

## Connecting NBJ/NBJ-B Call Switching Device

The NBJ/NBJ-B is a Call switching device, which can be used to control nurse calls at two locations. There are two possibilities in NBJ/NBJ-B application;

### 1. Switching to route calls on Master #2 to Master #1;

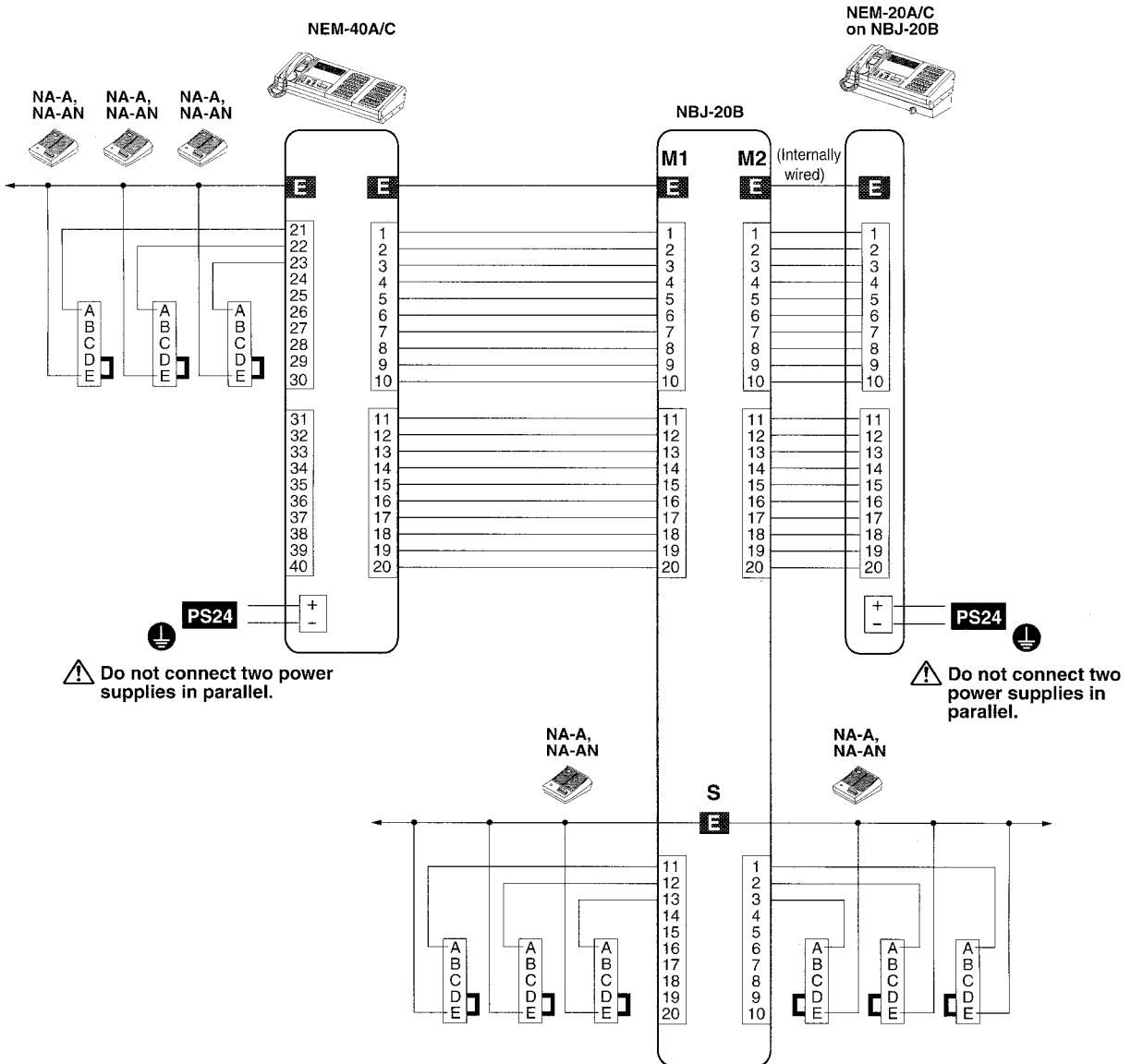
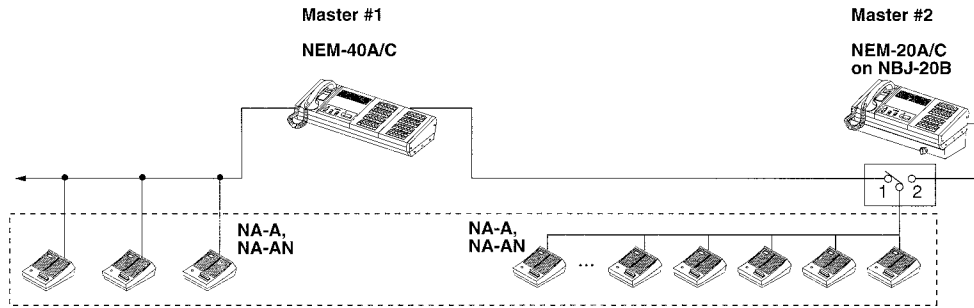

PS24 : 24V DC power supply

2. Switching from multiple NEM locations to a grand NEM master;

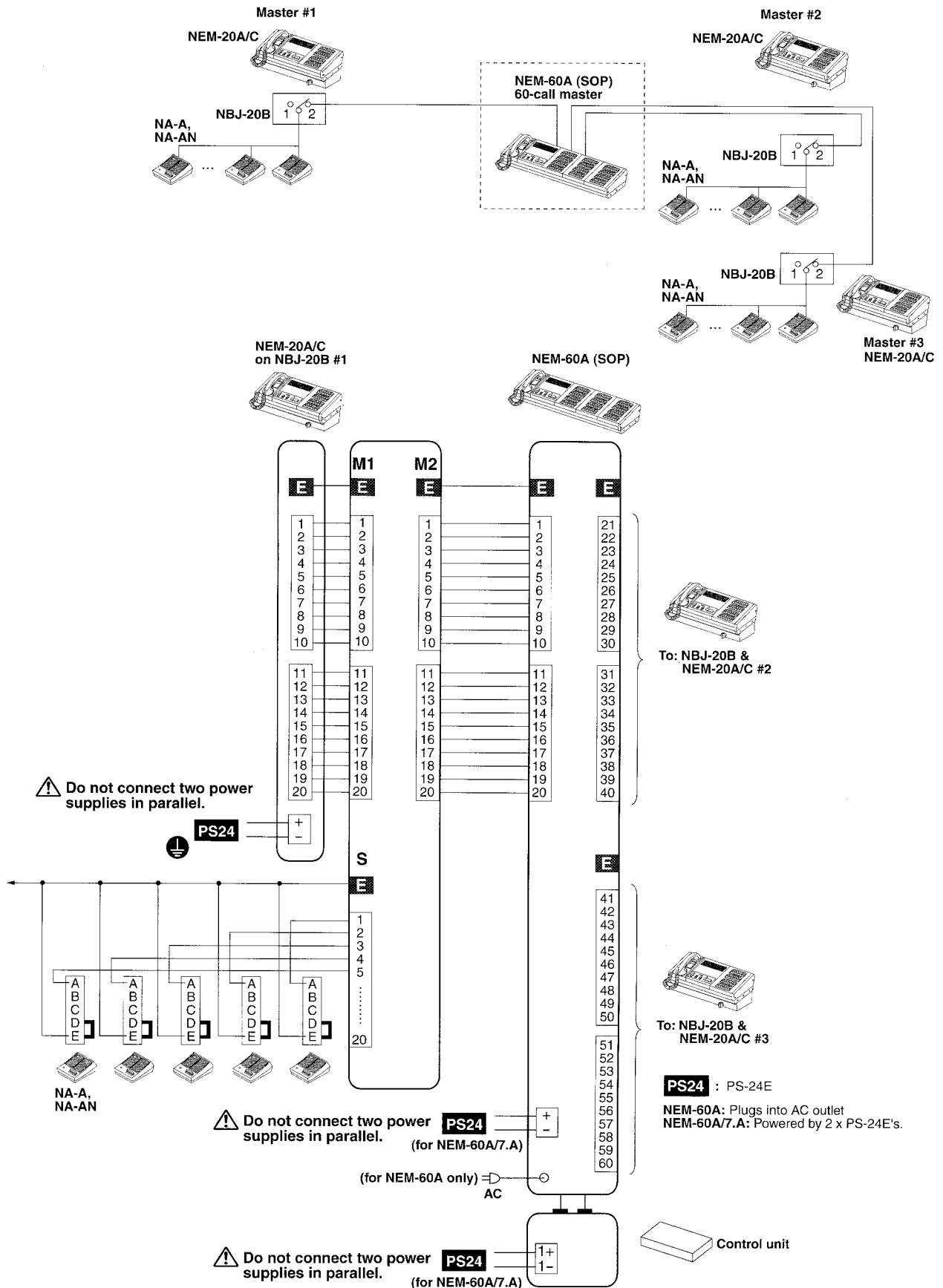

### NB-U music distribution

Music distribution to NA sub stations is an additional option to NEM system.  
Use an NB-U adaptor in conjunction with a 10W amp. & music source.

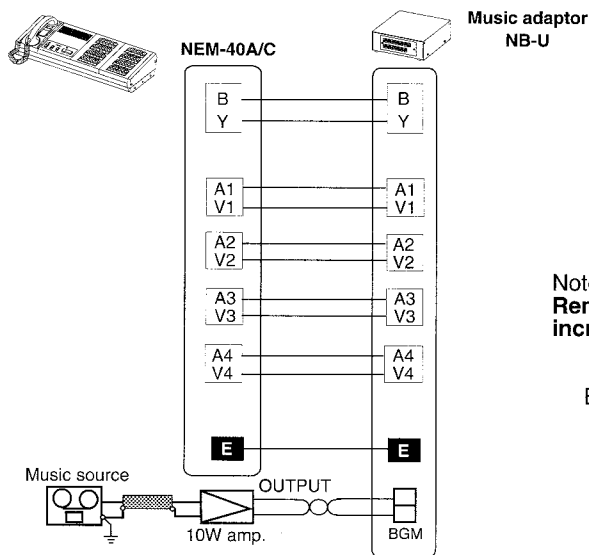

Notes:  
**Remove a jumper on An, Vn per 10 NA sub station increment.**

Example;

- Terminals A1, V1 used for NEM-10(A)/C
- Terminals A1, V1 ~ A2, V2 used for NEM-20(A)/C
- Terminals A1, V1 ~ A3, V3 used for NEM-30(A)/C
- Terminals A1, V1 ~ A4, V4 used for NEM-40(A)/C

### NA sub stations: Dual master call application

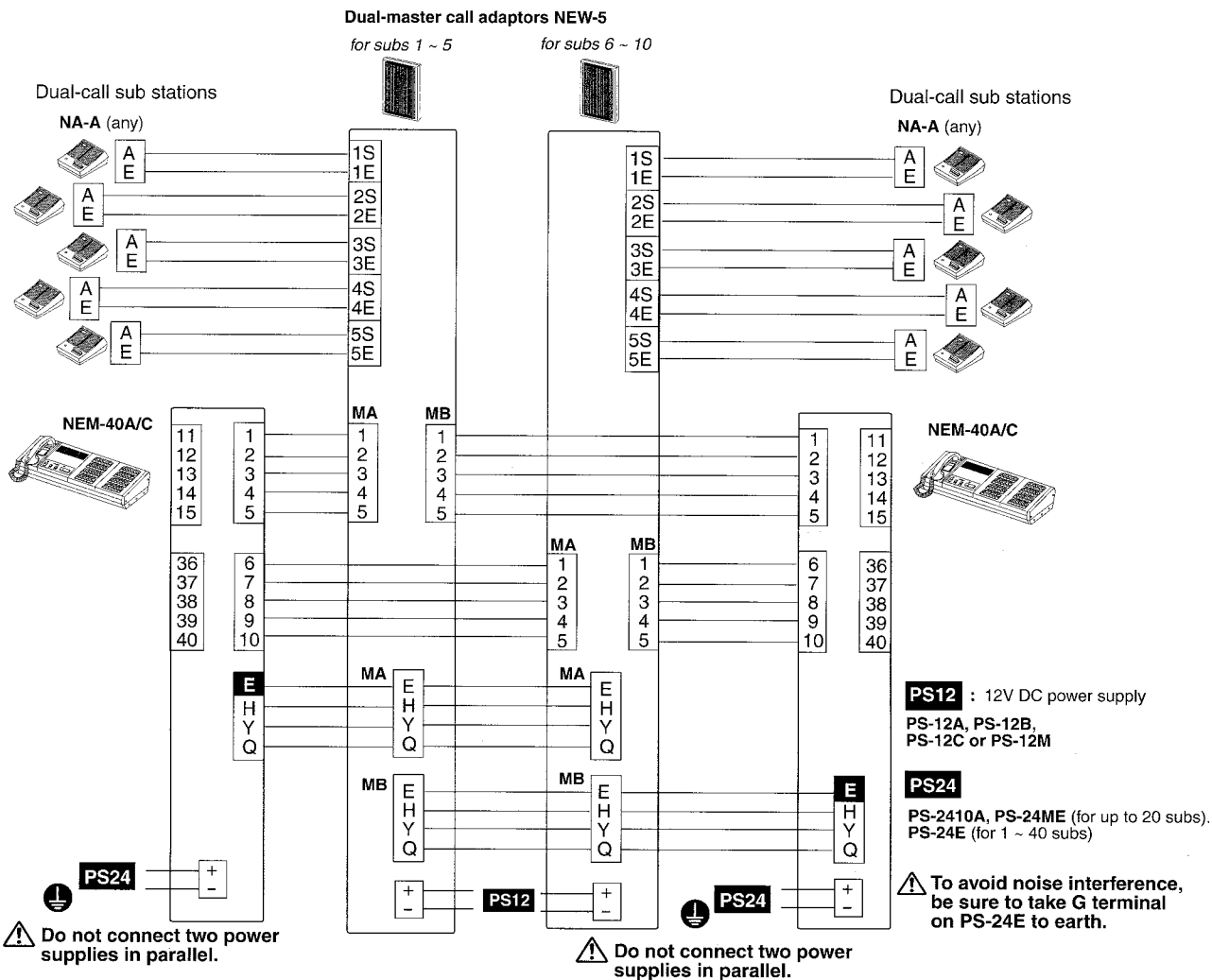

# 6 MOUNTING

## NEM- master station

NEM master station is placed on desk-top and install an appropriate power supply within proximity of the NEM console. Plug the power supply into an AC outlet provided.

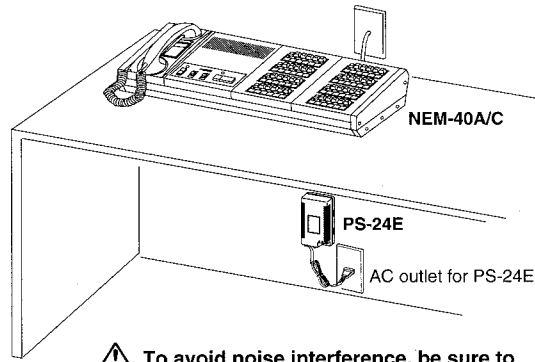

⚠ To avoid noise interference, be sure to take G terminal on PS-24E to earth.

SIDE VIEW

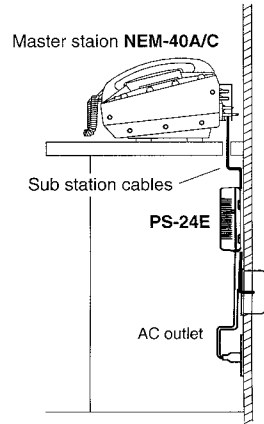

### NB-L

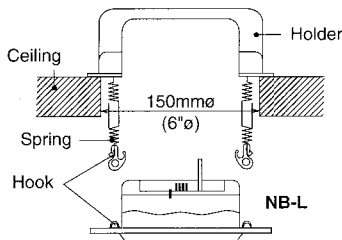

### NA-NE

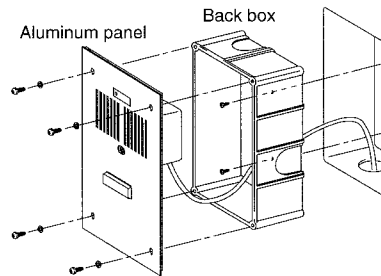

BACK BOX  
185H X 128W X 66D (mm)  
7-5/16"H X 5"W X 2-5/8"D

ALUMINUM PANEL  
220H X 160W X 2D (mm)  
8-5/8"H X 6-5/16"W X 5/64"D

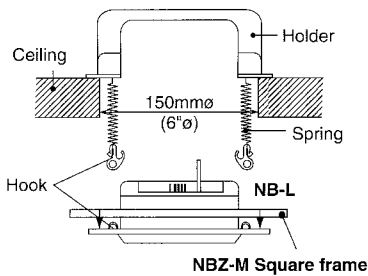

### NA-A, NA-AN

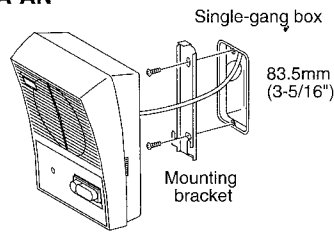

### NA-T/A

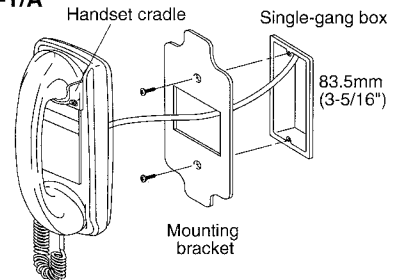

### NBY-1A

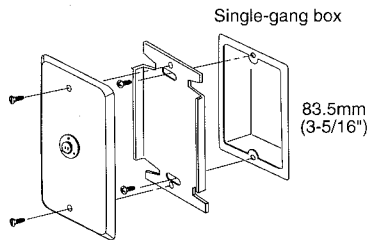

### NAR-3

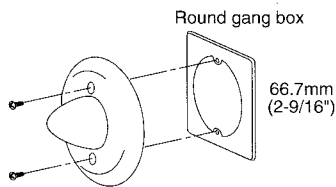

\* NAR-3: Not available in USA

### NBR-7AS NBR-7AS-S

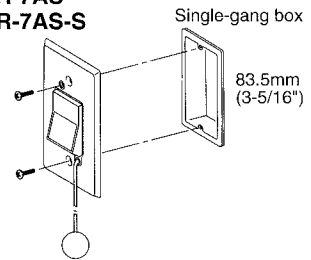

### NAR-2A, NAR-6A

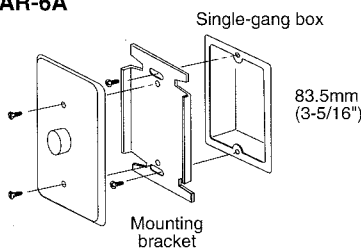

### NBY-4A NR-4AS13

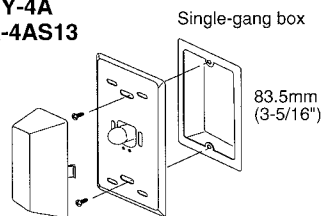

### NP-W

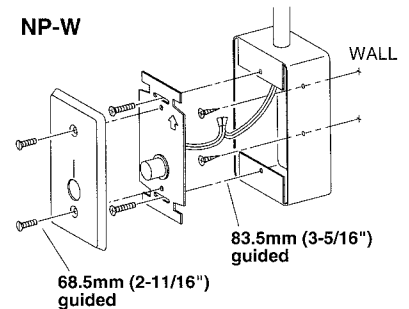

# 7 OPERATIONS

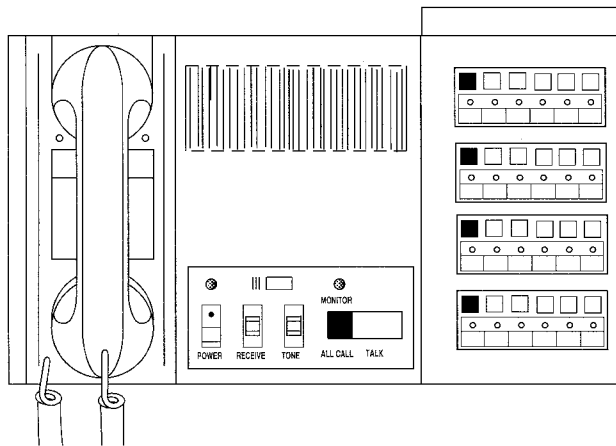

## TURN ON POWER SWITCH.

Plug the power supply into AC outlet. Turn on the power of NEM. The LED above illuminates to indicate. The NEM must be always in powered status.

### Calling an NA sub

1. Depress a sub selector button.
2. Depress TALK switch to transmit voice.
3. Release TALK switch to listen to sub.
4. At the end, depress OFF button.

### Receiving a call

1. Sub's call-in sounds an intermittent electronic tone and lights the selector LED on.
2. Depress the lit selector button.
3. Use TALK switch to control communication.
4. Depress OFF button to disconnect the line.

### ALL CALL

1. Depress and hold down ALL CALL switch, and speak into the mic. or lifting handset. Voice monitor LED blinks.
2. Just release ALL CALL switch to terminate the mode.

### ALL CALL to selected NA subs

1. Depress 2 to **max. 10** sub selector buttons, as desired.
2. Transmit message, depressing TALK switch.
3. To put system in standby, depress to lock all OFF buttons.

Health Care communication: –

### Calling from bedside

1. Momentarily press bedside call switch NBR-8A.
2. Call-in rings intermittent electronic tone and lights on a selector LED.
3. NBR-4A corridor light turns on red.
4. Depress a lit selector button, and communicate with TALK switch.

### Calling from NBR-7AS

1. Press hard on nurse-marked button NBR-7AS. Or pull down cord.
2. NEM is called by intermittent electronic tone and an LED red lit.
3. Depress a lit selector button only to silence tone. Go to the calling location.
4. At the bathroom, press hard on the upper end of CALL button. The call is reset, and corridor call light goes off.

Dual NEM master system: –

### Common sub call-in

1. Momentarily depress CALL button. Master RING LED is lit.
2. Two NEM masters ring simultaneously.
3. Either NEM depresses a lit selector button. Pre-tone sounds at the selected NA substation.
4. Communicate.

*The call self cancels at the other NEM, while Occupied LED (output monitor) is only lit. But, it can place a call to any other sub (crosstalk may occur).*

### Adjustments

NEM master station has daily adjust RECEIVE & TONE controls, and preset volume controls on back panel. Only for RECEIVE volume, prior to adjusting the back RECEIVE control, put to MID position the front RECEIVE control.

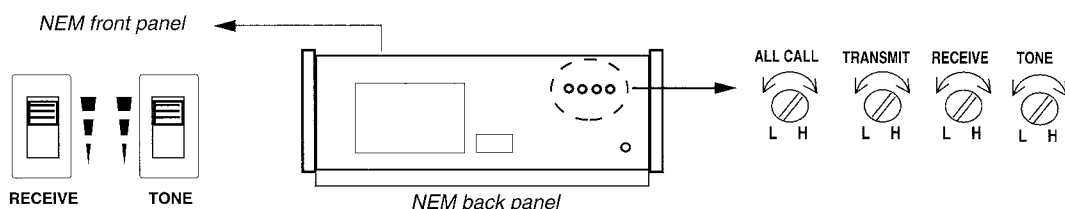

## 8 TECHNICAL PRECAUTIONS

### Operating temperatures

NEM & NEM-A master stations are rated to operate at temperatures between 0° ~ 40°C (32°F ~ 104°F).

### Mounting locations

The NEM equipment is not explosion proof type. Do not install any unit in a place filled with igniting gas.

### Operation

At end of every communication, be sure to depress corresponding OFF button, which disconnects the sub station as well as puts system in standby. Otherwise, call tone will not sound audibly.

### When asking for repairs

When system malfunctions, do not attempt to remove or change any unit. Call the installing dealer or representative.

### Cleaning

Clean NEM equipment with a soft cloth dampened with neutral household cleanser. Never use any abrasive cleaner or cloth.

## 9 SPECIFICATIONS (NEM(-A)/C)

- **Power source:** 24V DC.
- **Power consumption:** Max. 24W. 2W in standby (20-call) Max. 45W. 4W in standby (40-call). PS-2410A. PS-24ME (10 ~ 20-call). PS-24E (10 ~ 40-call).
- **Power supply:** PS-2410A. PS-24ME (10 ~ 20-call). PS-24E (10 ~ 40-call).
- **Calling:** Intermittent tremolo tone and lit LED, held until answered at master. Pre-tone and voice at sub.
- **Communication:** Open voice, press to talk or handset voice-actuation
- **Output:** Max. 500mW at NEM (w/adj. RECEIVE vol.) Max. 500mW at sub (w/adj. TRANSMIT vol.)
- **All call output:** 6W (up to 20 subs) 2W (21 to 40 subs) 3W (per 10 subs random selected)
- **Wiring:** 2 wires per NA sub station (1 for common E line).
- **Wiring distance:**

Cable size	ø0.65mm	ø0.8mm	ø1.0mm
Distance	130m	200m	300m

Cable size	22AWG	20AWG	18AWG
Distance	420'	650'	1,000'

### Dimensions & weight:

	H	W	D	Weight (approx.)
<b>NEM-10/C</b>	140 x	346 x	260	4/5Kg.
<b>NEM-20/C</b>	140 x	346 x	260	5.0Kg.
<b>NEM-30/C</b>	140 x	496 x	260	6.5Kg.
<b>NEM-40/C</b>	140 x	496 x	260	7.0Kg.
<b>NEM-10A/C</b>	176 x	446 x	260	5.5Kg.
<b>NEM-20A/C</b>	176 x	446 x	260	6.0Kg.
<b>NEM-30A/C</b>	176 x	596 x	260	7.5Kg.
<b>NEM-40A/C</b>	176 x	596 x	260	8.0Kg.
<b>NEM-10/C</b>	5-1/2" x	13-5/8" x	10-1/4"	9.92 lbs.
<b>NEM-20/C</b>	5-1/2" x	13-5/8" x	10-1/4"	11.02 lbs.
<b>NEM-30/C</b>	5-1/2" x	19-1/2" x	10-1/4"	14.33 lbs.
<b>NEM-40/C</b>	5-1/2" x	19-1/2" x	10-1/4"	15.43 lbs.
<b>NEM-10A/C</b>	7" x	17-5/8" x	10-1/4"	12.13 lbs.
<b>NEM-20A/C</b>	7" x	17-5/8" x	10-1/4"	13.23 lbs.
<b>NEM-30A/C</b>	7" x	23-1/2" x	10-1/4"	16.53 lbs.
<b>NEM-40A/C</b>	7" x	23-1/2" x	10-1/4"	17.64 lbs.

### WARRANTY

Aiphone warrants its products to be free from defects of material and workmanship under normal use and service for a period of one year after delivery to the ultimate user and will repair free of charge or replace at no charge, should it become defective upon which examination shall disclose to be defective and under warranty. Aiphone reserves unto itself the sole right to make the final decision whether there is a defect in materials and/or workmanship; and whether or not the product is within the warranty. This warranty shall not apply to any Aiphone product which has been subject to misuse, neglect, accident, or to use in violation of instructions furnished, nor extended to units which have been repaired or altered outside of the factory. This warranty does not cover batteries or damage caused by batteries used in connection with the product. This warranty covers bench repairs only, and any repairs must be made at the shop or place designated in writing by Aiphone. Aiphone will not be responsible for any costs incurred involving on site service calls.

AIPHONE CO., LTD., NAGOYA, JAPAN  
 AIPHONE CORPORATION, BELLEVUE, WA, USA  
 AIPHONE EUROPE NV, ANTWERP, BELGIUM

NEM/C-I(E) 0901F

 **AIPHONE®**  
 Providing Peace of Mind  
 Printed in Japan (E)