

PAGING AMPLIFIER

MODELS: PG-10A (10 watts output)
PG-30A (30 watts output)
PG-60A (60 watts output)

AIPHONE PG-A paging amplifiers are designed for use with AIPHONE paging intercoms. 10 watts, 30 watts and 60 watts amplifiers are available and may be installed in multiples for greater output.

— INSTRUCTIONS —



This symbol on the nameplate means the product is Listed by Underwriters Laboratories Inc.

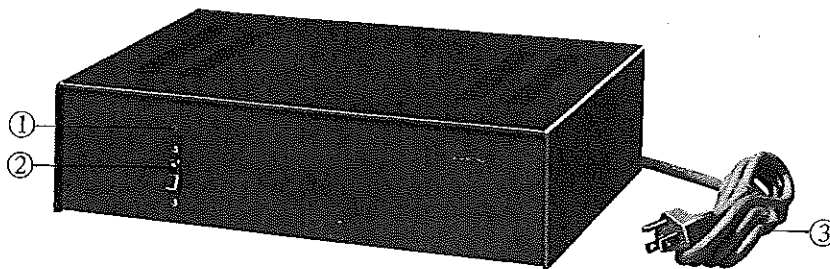

NAMES AND FUNCTIONS

- ① Power lamp
- ② Power switch
- ③ AC cord
- ④ Output (25/70.7 volt alternative)
- ⑤ Circuit breaker
- ⑥ Input terminals (A & E)
- ⑦ Fuse holder
- ⑧ G terminal for grounding

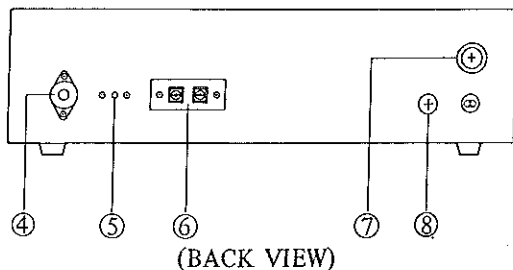

SPECIFICATIONS

- * Power output:
 - PG-10A 10 watts rms
 - PG-30A 30 watts rms
 - PG-60A 60 watts rms
- * Distortion: Less than 3% at 1,000 Hz rated output
- * Frequency response: ±3 db, 100 – 15,000 Hz
- * Input: 100 mV for rated output
- * Output: 25 volts and 70.7 volts balanced
- * Power requirements: 120 volts AC, 50/60 Hz
- * Power consumption:
 - PG-10A 30 watts
 - PG-30A 75 watts
 - PG-60A 130 watts
- * Dimensions:
 - PG-10A
245mm x 77mm x 152mm, 9-11/16" x 3-1/16" x 6"
 - PG-30A & PG-60A
340mm x 95mm x 205mm, 13-5/16" x 3-3/4" x 8-1/16"
- * Weight:
 - PG-10A 2.7 Kg, 6.0 LBS
 - PG-30A 5.0 Kg, 11.0 LBS
 - PG-60A 6.5 Kg, 14.3 LBS

FEATURES

- * Designed for use with AIPHONE intercoms in conjunction with paging adaptor.
- * Full range volume and tone controls on paging adaptor.
- * Amplifier output may be either 25V or 70.7V constant voltage balanced loads.
- * Complimentary transistor at the output stage ensures extremely low distortion and high damping factor.
- * Circuit breaker protects internal circuit against overloaded or shorted output line.
- * May be shelf or wall mounted.

INSTALLATION

Do not attempt to install your PG-A amplifier until you have read and thoroughly understood the installation procedure. Aiphone's warranty for the amplifier and the system is void if amplifier is installed in a manner other than described in this manual.

ADAPTOR REQUIREMENTS

The following AIPHONE intercoms have paging capability and may be connected to PG-A amplifier in conjunction with a paging adaptor. The type of adaptor must be decided according to the type of intercom system you install and the paging mode you wish to have. Each paging block requires one PG-A amplifier and appropriate number of speakers.

TYPE OF INTERCOM	ADAPTOR REQUIREMENTS		
	STRAIGHT PAGING	BLOCK PAGING	TALKBACK PAGING
① TA-F	one PG-U	not available	one PG-U and one PA-B
② TA-H ③ TA-Y	one PG-U	one PG-U and one PA-B per block	one PG-U and one PA-B per block
④ TS-K	one PG-U	one PG-U and one PA-B per block	one PG-U and one PA-B per block
⑤ KAH	one PA-1	one PA-1 per block	one PA-2 per block
⑥ TB-F	one PB-1	not available	one PB-1 and one PB-2
⑦ TB-H	one PB-1	one PB-1 per block	one PB-1 and one PB-2 per block
⑧ MC-3	one MC-A	not available	not available

Begin your installation by connecting the paging adaptor to your intercom system (and background music source if required) by referring to the instruction sheet of the paging adaptor packed with each unit. Requirements stated on the instruction sheet of the paging adaptor **MUST BE MET**.

After completing installation of both intercom system and the paging adaptor, then you may proceed to installation of PG-A amplifier. Unplug both power supply for intercom system and amplifier while making wiring connections.

AMPLIFIER INPUT CONNECTIONS

The greater the distance between the paging adaptor and the amplifier will increase the possibility of picking up R.F. signals or electrical noise.

The paging adaptor and amplifier should be located as close as possible to each other and shielded cable should always be used to connect them.

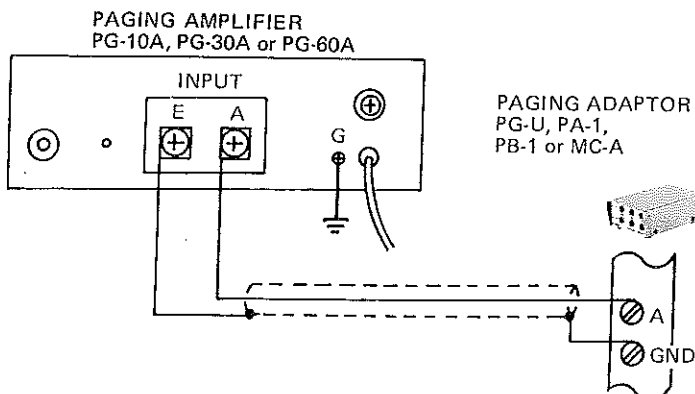

- 1) Connect output A terminal on paging adaptor to input A terminal on PG-A amplifier.
 - 2) Connect output GND terminal on paging adaptor to input E terminal on PG-A amplifier.
- * G terminal which has a green colored screw head must be ground for avoiding electric shock or hazard.

AMPLIFIER OUTPUT CONNECTIONS

Pull out the output plug and remove the cap. Insert speaker line, thru the cap, one into common pin indicated COM and the other into either 25V or 70.7V pin. Attach the conductors to the pins with low heat soldering. Replace the cap and insert the output plug into receptacle.

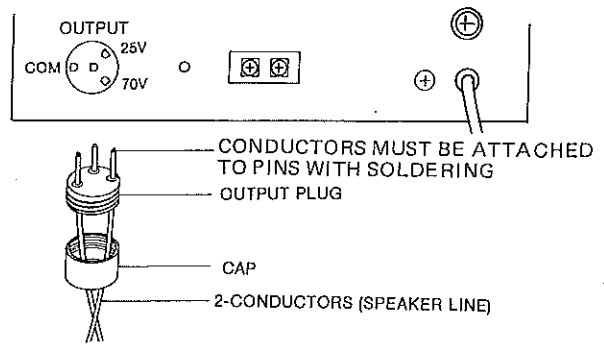

SPEAKER REQUIREMENTS

IMPORTANT

- 1 It is imperative that the total power consumed for speakers **MUST NOT EXCEED** the output power of amplifier i.e. maximum 10 watts for PG-10A, 30 watts for PG-30A and 60 watts for PG-60A. Greater output than 60 watts may be obtained by multiple installation of amplifiers. Refer to drawing below.
- 2 It is **NOT REQUIRED** to have a dummy load when the power consumed for speakers is less than the output power of amplifier.
- 3 A low impedance speaker such as 8 ohm horn must be installed using a matching transformer.
- 4 The total impedance of all speakers, matching transformers, and length of speakers run must be equal or more than the output impedance of the amplifier. Refer to chart below. After computing the resistance of your speaker, transformers, and speaker line, add a resistor in series to speaker line to increase impedance to match chart.

MULTIPLE INSTALLATION

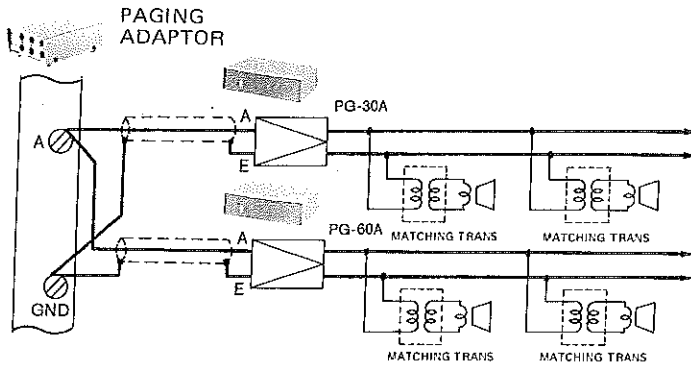

OUTPUT IMPEDANCE

	25 volt line	70.7 volt line
PG-10A	62.5 ohms	500 ohms
PG-30A	21 ohms	167 ohms
PG-60A	10.5 ohms	83 ohms

* Output of each amplifier (speaker line) **MUST BE SEPARATE.**

INSTALLATION EXAMPLE

- 1) This example illustrates connection of TB-H system with single zone paging without talkback.
- 2) In this example button #6 on each phone operates paging.

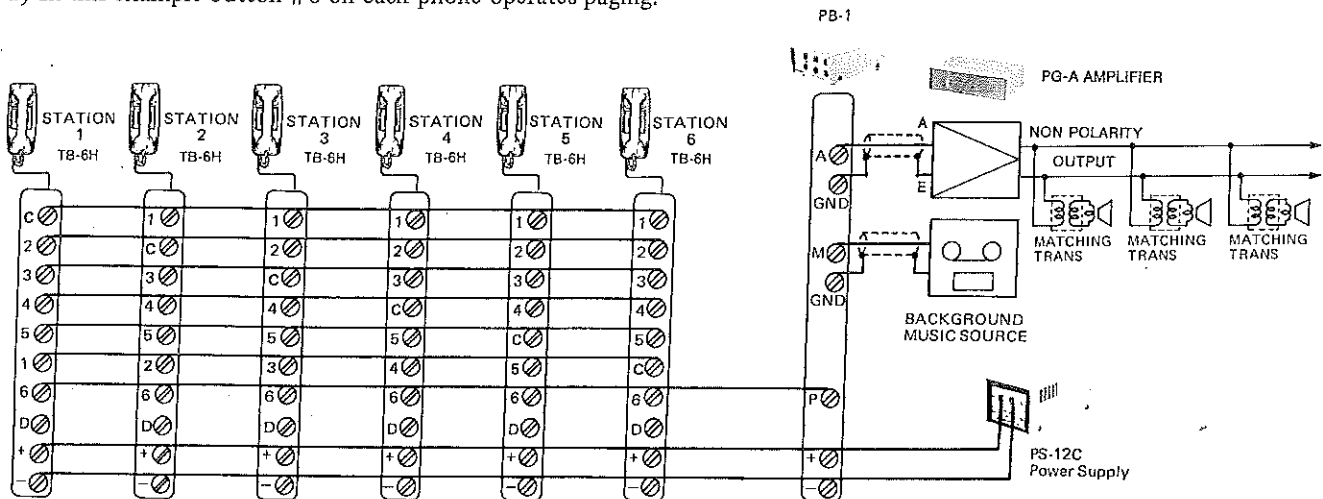

NOTE: Each paging adaptor requires different wiring.

Please refer to the instruction sheet packed with the adaptor you are going to install.

WALL MOUNTING INSTALLATION

Your PG-A amplifier is designed either for shelf or wall mounting. Please avoid placing the amplifier on dusty or humid floor.

- 1) Each amplifier is shipped complete with screws and bracket for wall mounting.
- 2) Attach the bracket to the bottom of amplifier.
- 3) Mount the amplifier upon the screws protruding from the wall.
- 4) Fix the attached bracket to the wall with the supplied screw.

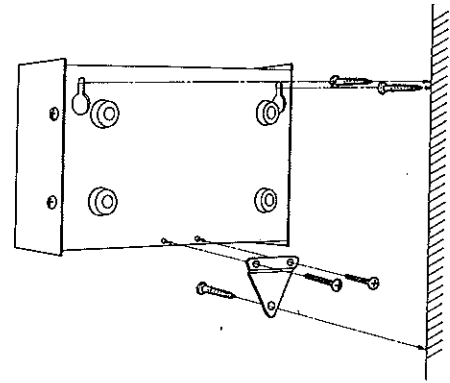

FIELD SERVICING

BREAKER

Your PG-A amplifier is equipped with a circuit breaker to protect the internal circuit from overloads or shorts in speaker line.

If you do not have any output to the speakers, make the following checks:

1. Check A.C. outlet — Unplug amplifier from A.C.
2. Check speaker line for either overloads, shorts, or opens — and repair.
3. Plug PG-A amplifier into A.C. outlet and press circuit breaker button.

FUSE REPLACEMENT

A slow blow fuse (1A for 10, 2A for 30, 3A for 60) is located on the rear of each amplifier. A blown fuse is generally caused by internal circuitry. Turn amplifier off and replace fuse. If the replacement fuse also goes out, refer amplifier to qualified personnel.

* * *

We at AIPHONE are proud of our products. Our designers and engineers strive to bring you the finest in communication equipment. Each item has been carefully tested and inspected before leaving our factory. Properly installed and used, your Aiphone intercom system should give years of troublefree service.

We are pleased to offer the following warranty:

WARRANTY

Aiphone warrants its products to be free from defects of material and workmanship under normal use and service for a period of one year after delivery to the ultimate user and will repair free of charge or replace at no charge, should it become defective upon which examination shall disclose to be defective and under warranty. Aiphone reserves unto itself the sole right to make the final decision whether there is a defect in materials and/or workmanship; and whether or not the product is within the warranty.

This warranty shall not apply to any Aiphone product which has been subject to misuse, neglect, accident, or to use in violation of instructions furnished, nor extended to units which have been repaired or altered outside of the factory.

This warranty does not cover batteries or damage caused by batteries used in connection with the product.

This warranty covers bench repairs only, and any repairs must be made at the shop or place designated in writing by Aiphone. Aiphone will not be responsible for any costs incurred involving on site service calls.