

AIPHONE

INTERNAL TELEPHONE SYSTEM TA-T SERIES

NAMES & FUNCTIONS

- ① A.C. Cord
- ② Telephone Handset
- ③ Communication Lamp
- ④ Annunciator Lamp
- ⑤ On Light
- ⑥ Off/On Switch
- ⑦ Cancel Switch (Button)
- ⑧ Selector Switch (Button)
- ⑨ Tone Volume Control (under side)
- ⑩ Terminal Block (Internal)

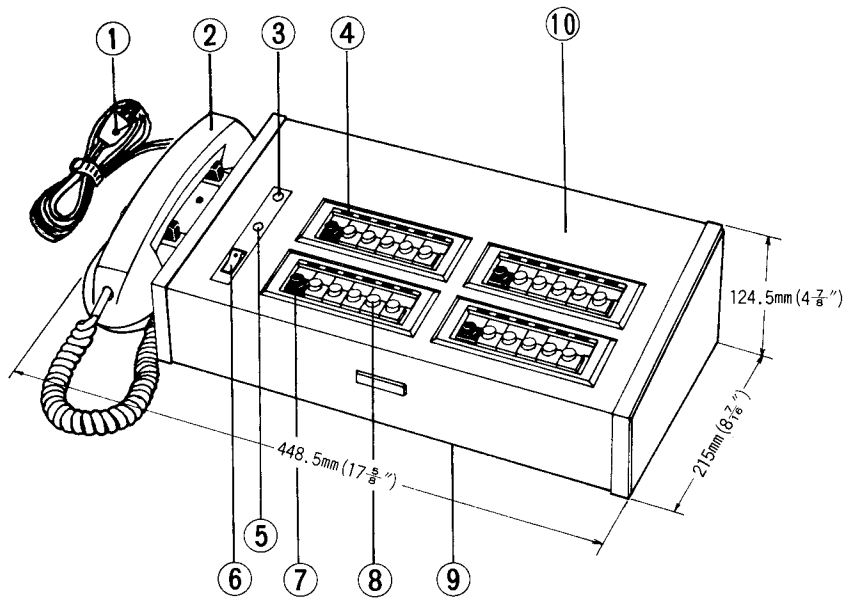

SPECIFICATIONS

- Power source: 110 – 117V, 220 – 240V, 50/60Hz
Current consumption: 4.6 watts
Capacity: 10, 20 & 30 station masters
20 station additional selector
Wiring: 2 conductors per sub
3 conductors between masters
6 conductors to additional selector
5 conductors to door station adaptor,
2 to door station

FEATURES

1. Tone & lamp annunciation on calling.
2. Telephone sub station with automatic call in.
3. Door station & adaptor available
4. Warning tone to indicate master has not been cleared.
5. Two masters per system.
6. Various combinations of conversation:
 - A - Master to Master
 - B - Master to Sub
 - C - Sub to Sub through Master
 - D - Master may set up conference
 - E - One Master to Sub of second Master

EQUIPMENT AVAILABLE FOR USE IN A TA-T SYSTEM

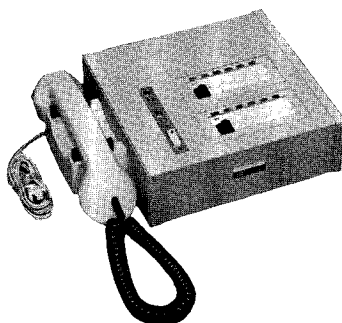

TA-10T 10-way master

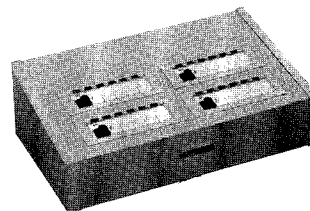

TA-20AS additional selector

EQUIPMENT AVAILABLE FOR USE IN A TA-T SYSTEM (Cont.)

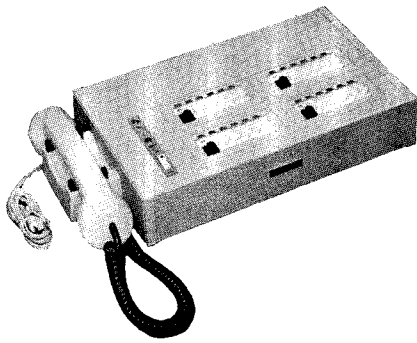

TA-20T
20-way master

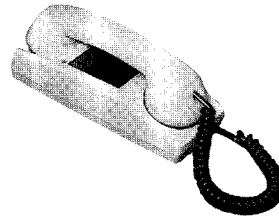

TA-RC sub station

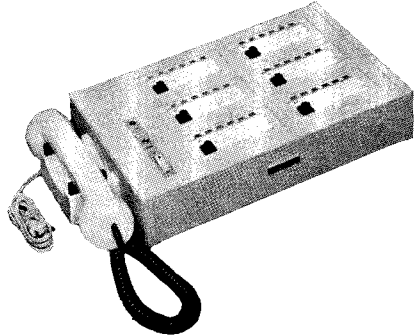

TA-30T
30-way master

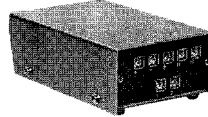

DA-TS door station adaptor
For one door station

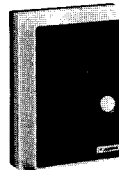

IA-DA door station W/LED
Use with DA-TS

INSTALLATION

Do not attempt to install your intercom system until you have read and understand these instructions. Aiphone's warranty is void if a system is installed in any manner other than that described in this manual.

ACTUAL TERMINAL LOCATIONS

The master station terminal block is located inside the unit. Unscrew the four screws holding the bottom plate and tilt top back and away from the bottom. Notice the slot in the rear of the cabinet for passing the cabling through to the terminal.

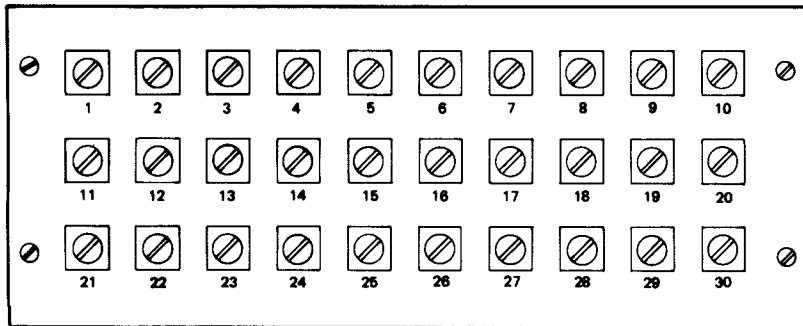

1 - 30 sub station number
 1 2 sub station number
 M, C, E for master to master connection
 +, -, D for door station adaptor connection
 G, H, T, K, +, - for additional selector connection

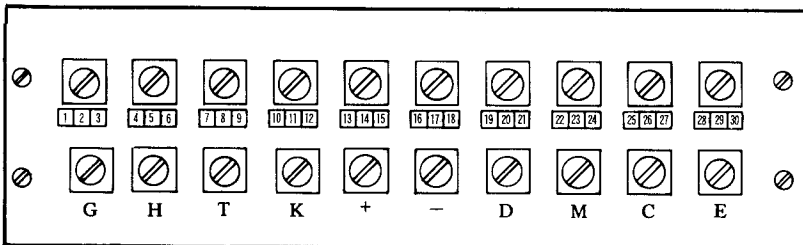

INSTALLATION FOR WALL MOUNTING

- 1) Attach the mounting bracket to wall or single gang plaster ring.
- 2) Remove handset cradle for desk use.

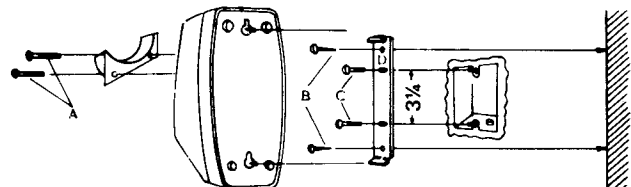

WIRING

Lay out your system in advance. Determine the location of each station and wiring to each. Two conductors are required from a master to each substation under control of that master. Three conductors are required between the two masters. Door station adaptor DA-TS should be located as near master as possible. Five conductors are required to DA-TS.

- * Connect a single pair of wires to TA-RC phone, and to numbered station terminals of master station which you wish to call.
- * Adjust call tone volume as desired on bottom of unit.
- * Do not common one side of pair at any other point than at master. Doing so will affect proper operation of your system. Refer to diagrams below.

Refer to chart below and select the proper size wire for your needs.

	24 AWG	22 AWG	20 AWG	18 AWG
Master to Sub	660'	1400'	2000'	3200'
Master to Master	330'	660'	990'	1575'
DA-TS to IA-DA	300'	500'	660'	990'
	.5 mm	.65 mm	.8 mm	1.0 mm
Master to Sub	200 m	400 m	600 m	900 m
Master to Master	100 m	200 m	300 m	480 m
DA-TS - IA-DA	90 m	150 m	200 m	300 m

After installation of a master and one substation, we recommend that the system be turned on and tested for proper operation. The system should further be tested after the addition of each five stations. (Caution: Unplug power cord during wiring.)

TA-10T Master with 10 sub stations

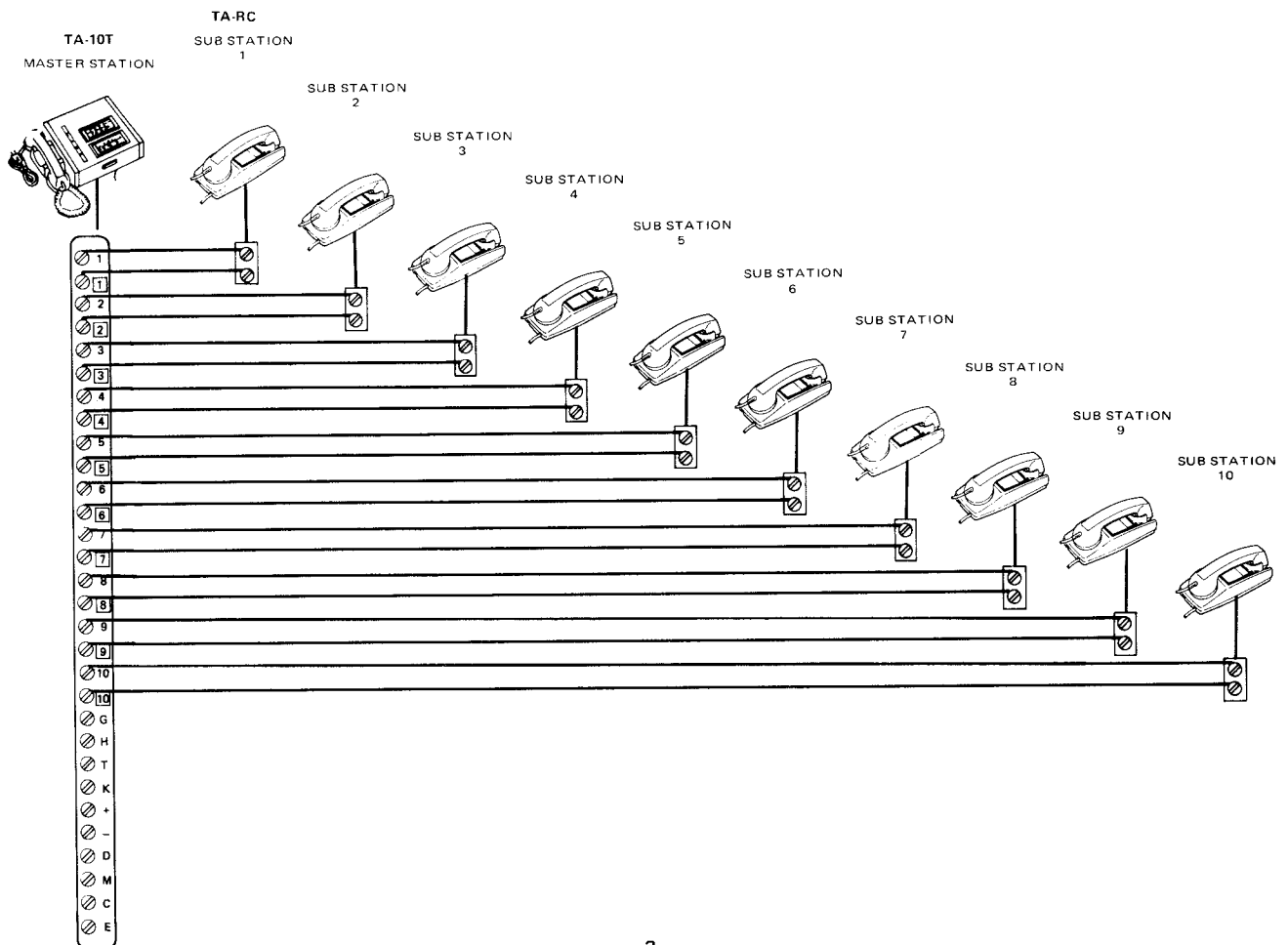

TA-10T Master with 2 door stations

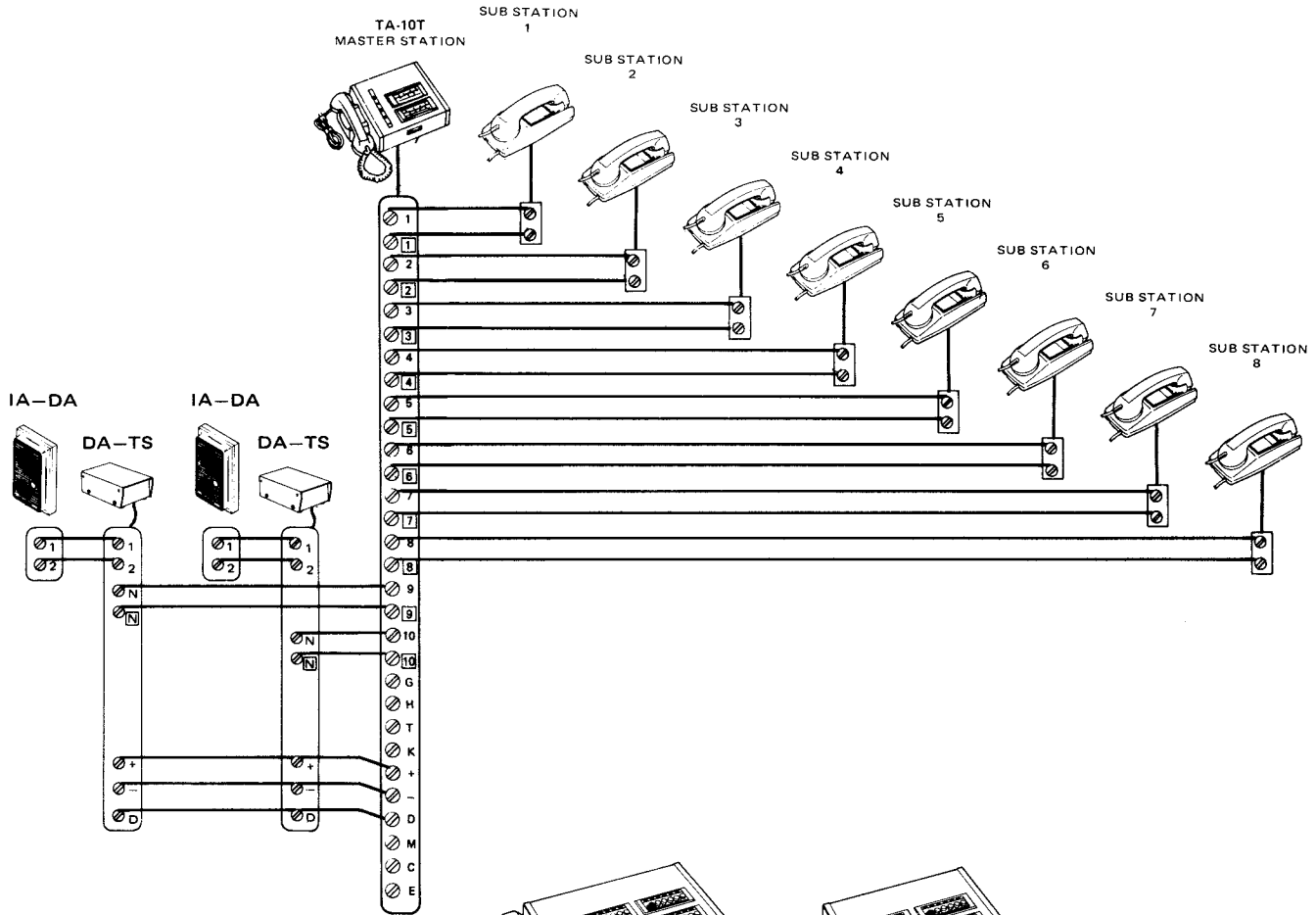

TA-20T Master with TA-20AS and subs

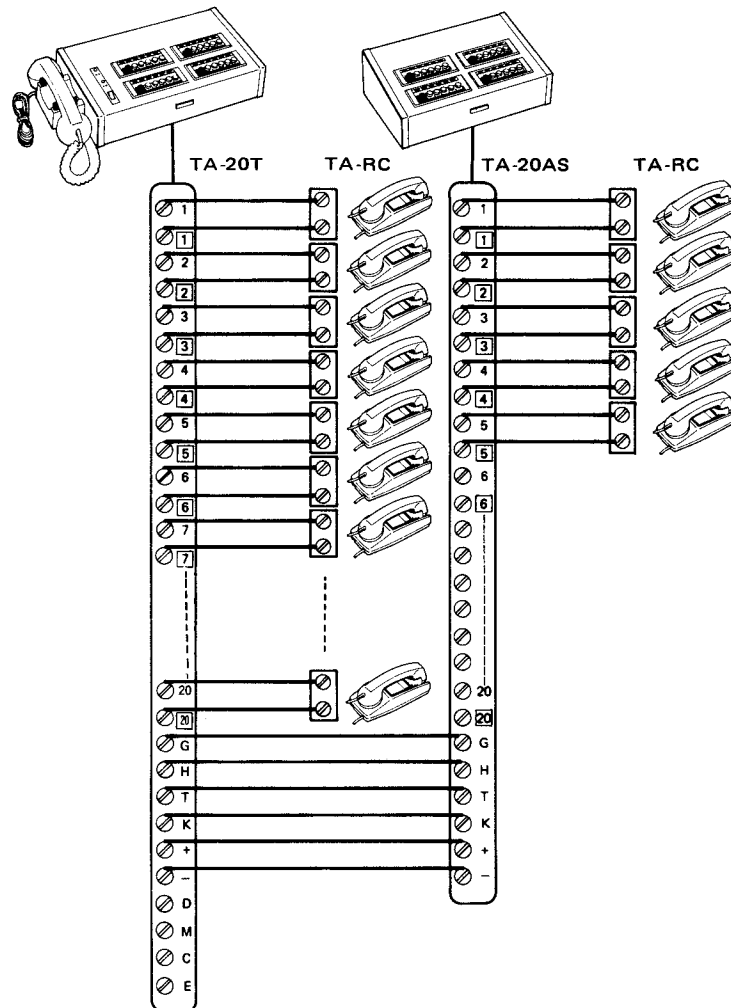

2-TA-10T with 9 sub stations each

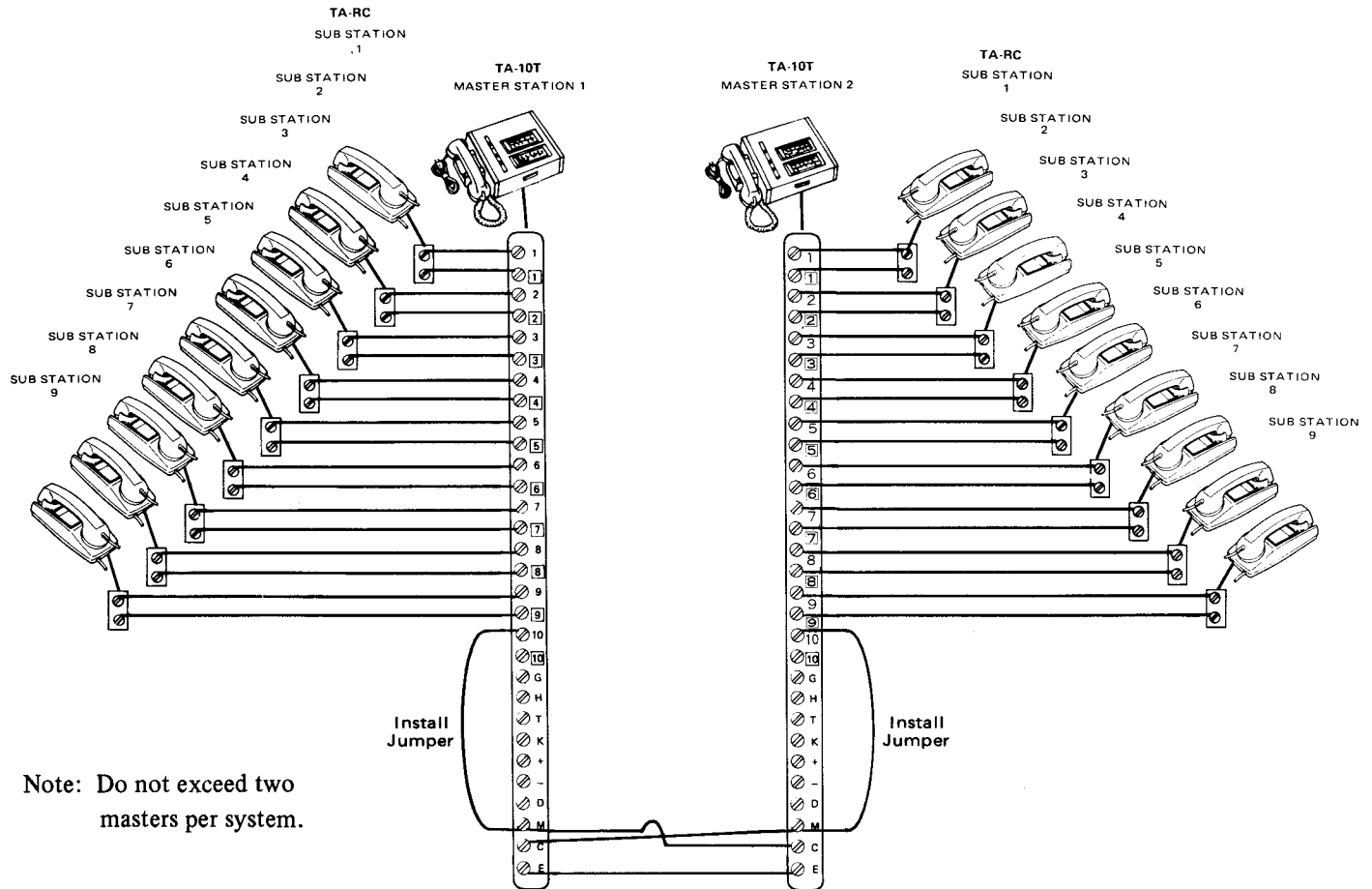

Note: Do not exceed two masters per system.

TA-10T WITH DOOR STATION

Door station may be connected to TA-10, 20 or 30-T.

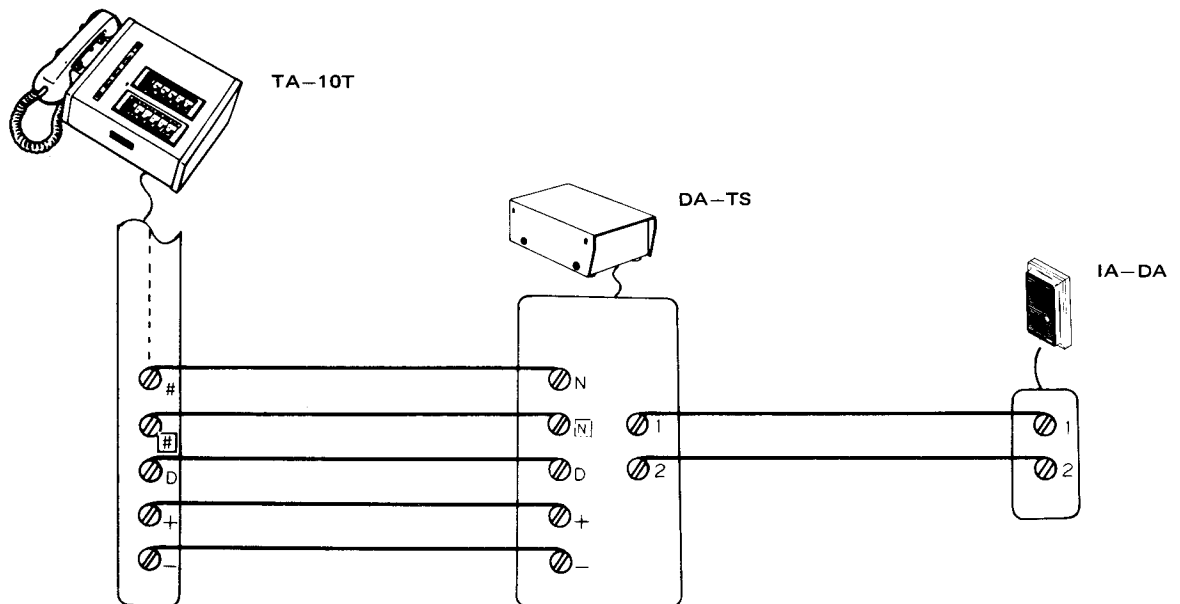

MOUNTING IA-DA SURFACE MOUNT

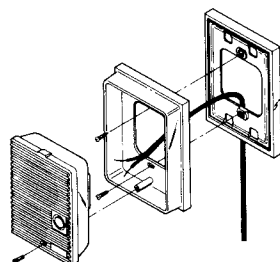

BOX MOUNT

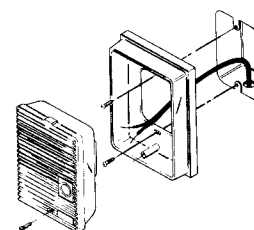

INSTALLATION OF DOOR STATION

- * Terminal N indicates number to which door will annunciate.
- * DA-TS should be mounted so as to keep wiring to the master as short as possible.
- * Mount door station to wall or box as desired.
- * Connect terminals 1 and 2 to IA-DA - observe polarity.
- * Connect terminals +, -, D, N & **N** to master station.

OPERATION

Master Station

1. Receiving a call
 - A. Incoming calls are annunciated by tone and lamp.
 - B. Lift the handset and depress the selector button under the illuminated lamp.
 - C. If a second station calls while the master is busy the annunciator lamp will illuminate but the tone will not sound.
 - D. If a door station calls the annunciator lamp will illuminate for approximately 20 seconds, and the tone will sound unless the master is busy.
 - E. Depress black cancel button at the end of every conversation. A tone will sound to remind you.
2. Placing a call
 - A. Lift handset and depress selector button of station desired. Your call will automatically be annunciated by audio tone.
3. Conversation between subs can be accomplished as follows (except to door station):
 - A. Station number one calls master and indicates that it would like to talk with station number three.
 - B. The master places station one on hold by depressing cancel button and then calls station number three and informs him that station number one is waiting to talk with him.
 - C. The master then selects number one again and hangs up. NOTE: If both parties are in the same row of switches the operator must depress both buttons simultaneously.
 - D. At the end of the conversation both parties hang up and a tone will sound, reminding the master to cancel the selector switches.

SUB STATION TA-RC OPERATION

To place a call simply lift the handset and wait for the master station to answer. A tone will be heard indicating the master is ringing. If a faster repeated tone is heard, the master is busy and you should try again later.

CLEANING YOUR INTERCOM STATIONS

- * Your Aiphone intercom stations may be cleaned with a soft cloth dampened with household cleanser, such as Mr. Clean or Fantastik.

We at AIPHONE are proud of our products. Our designers and engineers strive to bring you the finest in communication equipment. Each item has been carefully tested and inspected before leaving our factory. Properly installed and used, your Aiphone intercom system should give years of trouble-free service.

We are pleased to offer the following warranty:

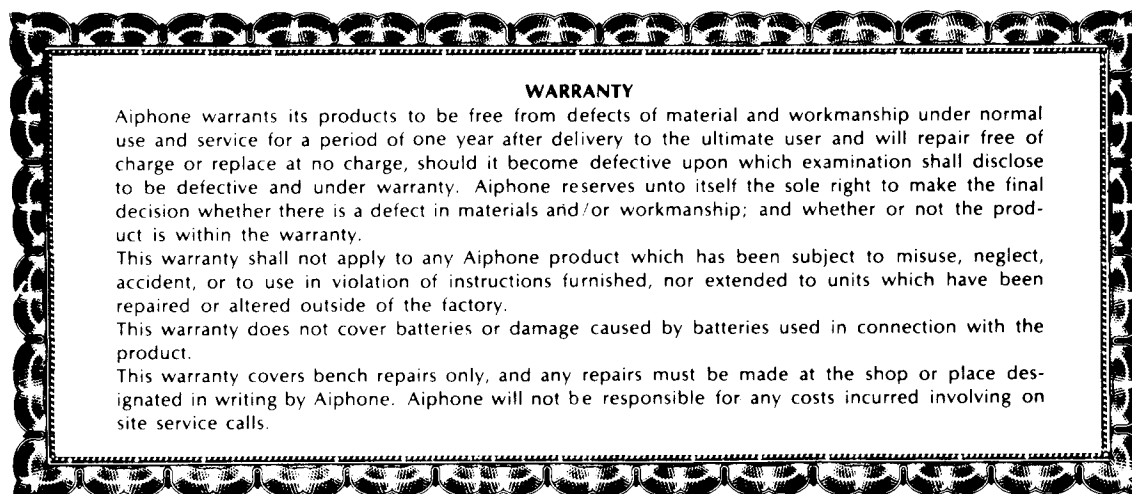

ALL OVER THE WORLD **AIPHONE**