

TB-M Series
10-call PanTilt Door Adaptor

Model: **TB-ADM10**

INSTALLATION & OPERATION MANUAL

CONTENTS

1 SYSTEM OUTLINE & COMPONENTS.....1

2 NAMES & FEATURES.....2

3 PRECAUTIONS ON INSTALLATION & WIRING.....2

4 WIRING.....3

5 MOUNTING.....5

6 OPERATIONS.....6

7 TECHNICAL PRECAUTIONS.....8

8 SPECIFICATIONS.....8

1 SYSTEM OUTLINE & COMPONENTS

TB-ADM10 is a 10-call PanTilt door adaptor for use with TB-M Internal Telephone System. Using TB-SE sub handset capacity, TB-M may incorporate up to 10 MY PanTilt or IE/IF audio door stations.

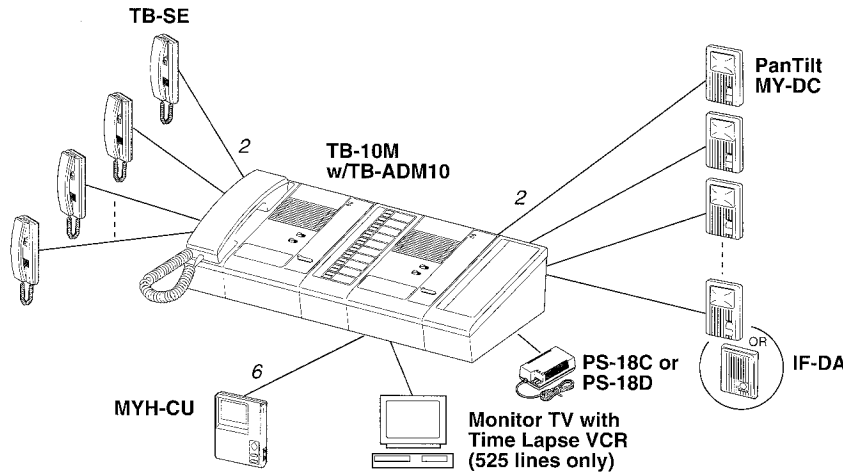

★A monitor TV must be used for Auto-Scanning, which exceeds usual 2.5 minutes on MYH-CU (together with Time-Lapse VCR).

Package contents

- TB-M 10-call PanTilt door adaptor (TB-ADM10)
- Junction cable (2)
- Packet of screws
- Installation & Operation Manual

Components available

TB-ADM10	TB-10M, TB-20M	MYH-CU	PS-18C, PS-18D	Monitor TV, Time Lapse VCR
10-call PanTilt door adaptor 	10 or 20-call master 	Video monitor, surface-mount 		

• With TB-20G or TB-40G add-on selector

• Scanning line 525 lines only

■ Components available

• Video door stations, PanTilt or Wide-angle

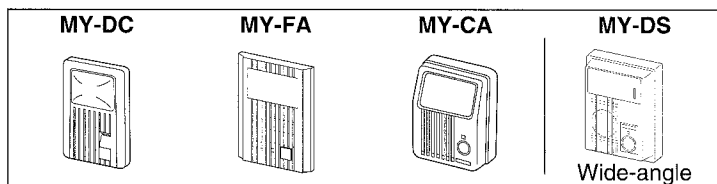

* Others: MY-DG, metal panel,
MY-EA

• Audio door stations

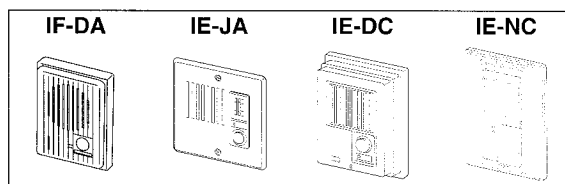

* Others: IE-FY, aluminum panel

2 NAMES AND FEATURES

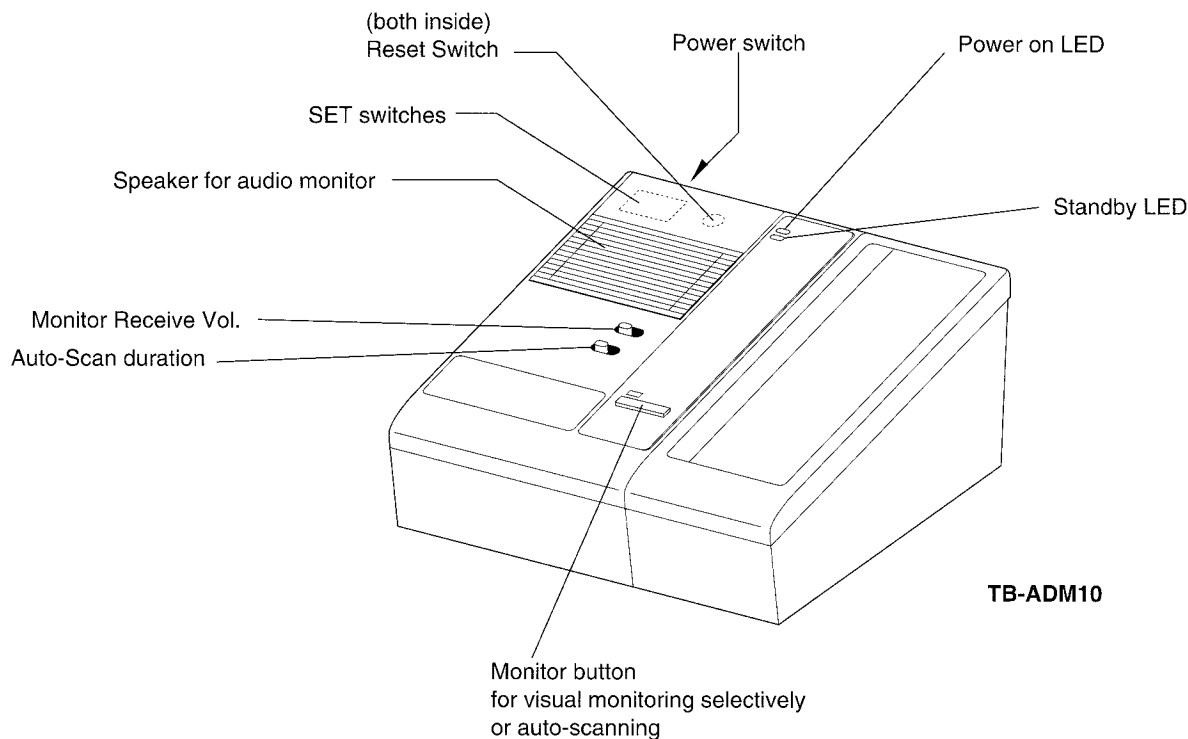

■ FEATURES

- * Max. 10 PanTilt video control and communication
- * Outdoor remote can be either PanTilt MY Series, audio IE/IF Series, or overhead camera
- * Auto-scanning with 10 to 30 second duration
- * Video output to monitor TV and/or time-lapse VCR (525 lines only)

3 PRECAUTIONS ON INSTALLATION & WIRING

⚠ CAUTION

- ★ TB-ADM10 is an electrical device operating on low DC voltage. Do not connect any terminal on any unit to AC power lines to prevent fire or unit damage.
- ★ Do not attempt to install or connect wires on TB-ADM10 while system's power supply is plugged in.
- ★ TB-ADM10 is for indoor installation only. Do not install outdoors.

■ Before installing TB-ADM10, refer to Precautions stated in TB-M Series Manual.

4 WIRING

■ Terminals block layout

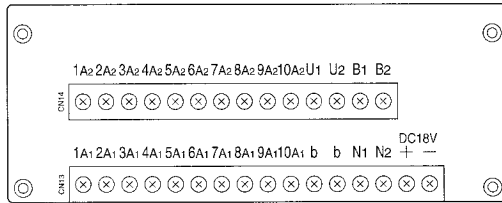

10 pairs of A1, A2 terminals for PanTilt door stations
★ Do not cross wires with other door stations.

Terminal symbols

1. Door station audio, video & PanTilt signals

1A1, 1A2 (door 1) ~ 10A1, 10A2 (door 10)

2. For MYH-CU monitor

+, - : 18V DC power supply

U1, U2 : control

B1, B2 : Video output

3. For external device

b, b : Control of Time-Lapse VCR

(to its control terminal)

Coaxial cable connector to video input on Monitor TV

N1, N2 : unused

■ TB-M entry call system

TB-M is capable of connecting only one entry call adaptor, audio or video. So, it is not possible to use TB-AD1 or TB-AD10 adaptors together with TB-ADM10 within a system.

● Video monitor capacity

Only one MYH-CU video monitor can be mounted along with TB-M console.

● Cable

Using cable must be a parallel cable for each door station. Do not use multi-pair cable.

● Connecting TB-ADM10 to TB-M or TB-G add-on selector

TB-ADM10 is equipped with two junction cables of 100cm long. Plug in connectors to inside sockets, which are located on PC board of TB-M & TB-G. It decides automatically a select switch bank for door stations.

★ When TB-ADM10 is plugged to TB-M or TB-G, the terminals of corresponding switch banks can not be used for TB-SE subs.

● Pre-tone on/off setting

Remove a cover on top left of TB-ADM10. Do not change A setting, which is preset for TB-M. The second switch when put to above ON position, validates pre-tone, which sounds at door station (any), upon selected by TB-M.

● Reset switch

When TB-ADM10 malfunctions, press Reset switch.

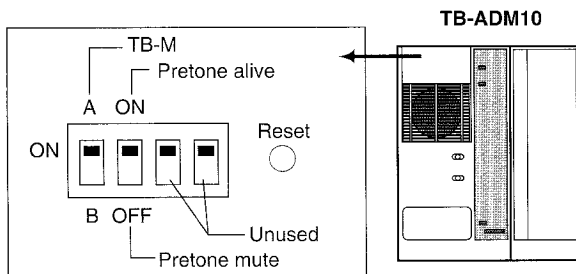

● Junction cable alignment

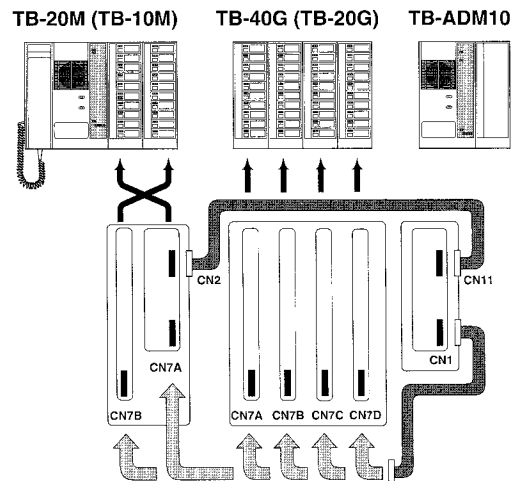

■ WIRING DIAGRAM

● TB-10M with five MY video entries

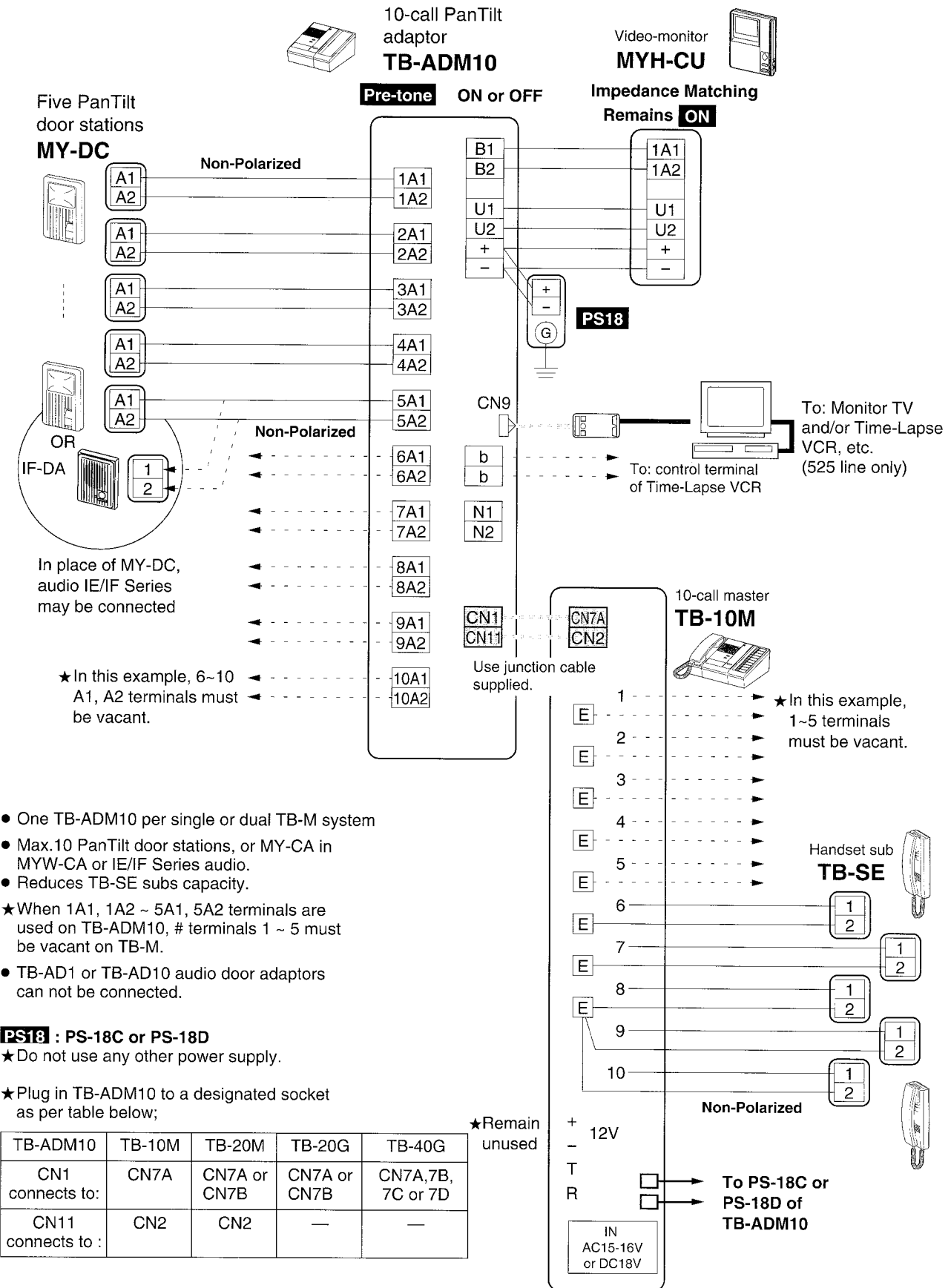

- One TB-ADM10 per single or dual TB-M system
- Max.10 PanTilt door stations, or MY-CA in MYW-CA or IE/IF Series audio.
- Reduces TB-SE subs capacity.
- ★ When 1A1, 1A2 ~ 5A1, 5A2 terminals are used on TB-ADM10, # terminals 1 ~ 5 must be vacant on TB-M.
- TB-AD1 or TB-AD10 audio door adaptors can not be connected.

PS18 : PS-18C or PS-18D

★ Do not use any other power supply.

★ Plug in TB-ADM10 to a designated socket as per table below;

TB-ADM10	TB-10M	TB-20M	TB-20G	TB-40G
CN1 connects to:	CN7A	CN7A or CN7B	CN7A or CN7B	CN7A,7B, 7C or 7D
CN11 connects to :	CN2	CN2	—	—

5 MOUNTING

• Desk-top mounting

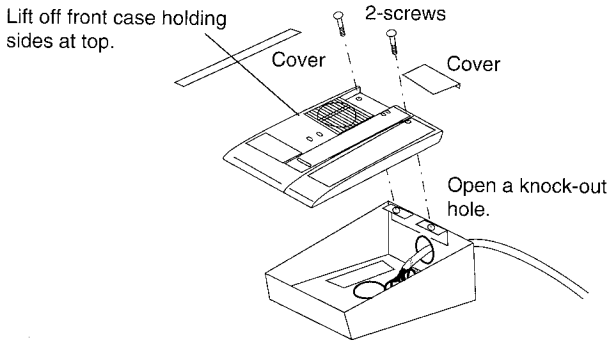

• Wall-mounting

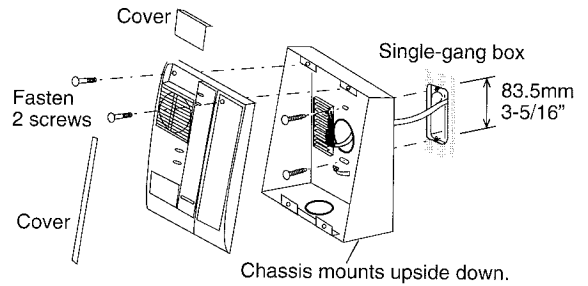

■ TB-ADM10

1. Remove 2 screws on front panel, removing 2 covers.
2. Lift off front case holding sides at top.
3. Disconnect TB-ADM10, plugging off connector.
4. Open a cable inlet hole (rubber part) on rear or bottom of chassis.
5. Pull in cable(s), and make wire terminations.
6. Use attached cable clamp(s) for neat and secured connection.
7. Reconnect and mount front case to chassis, attaching the covers to place.

★ For wall-mounting, the chassis must be mounted upside down.

■ When wall-mounted with TB-M (and TB-G)

Decide an exact location of TB-M master, and the next unit(s) attachedly mounts with the guides below;

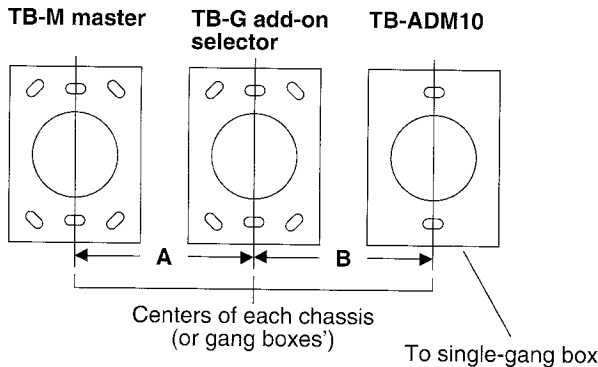

Wall-mounting guide

Unit : mm

Master	Attached	Guide A	Attached	Guide B
TB-10M	TB-20G	202.5	TB-ADM10	172.5
	TB-40G	277.5	TB-ADM10	247.5
	TB-ADM10	225.0	—	—
TB-20M	TB-20G	240.0	TB-ADM10	172.5
	TB-40G	315.0	TB-ADM10	247.5
	TB-ADM10	262.5	—	—

■ Coaxial cable connection

Attach cover to the box which fastens braided conductors.

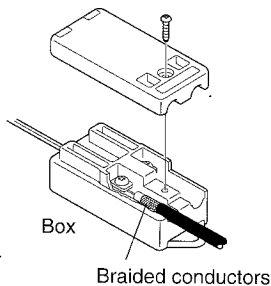

Terminate core conductor on screw terminal.

★ Processing conductor end

5C-2V or
RG-59/U (20GA)

3C-2V or
RG-59/U (22GA)

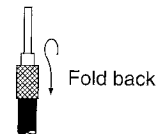
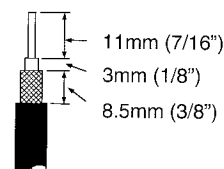

6 OPERATIONS

■ Pan and tilting MY camera

While MYH-CU monitor is on, pan and tilt the MY door camera.

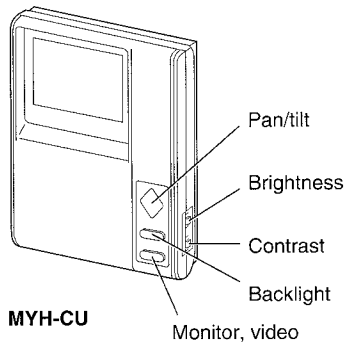

Camera
tilts down.



Camera pans to right.

■ Receiving a call from MY door station

1. Press CALL button on MY door station.
2. Intermittent tremolo rings on TB-M. The LED is lit to indicate. MYH-CU turns on. It times out in 40 seconds.
3. Pick up TB-M handset, and press a designated button.
4. Communicate. Image is alive for 2-1/2 minutes.
5. When MYH-CU turns off, press MONITOR button on TB-ADM10 to resume.
6. At conclusion, hang up TB-M handset. MYH-CU turns off.

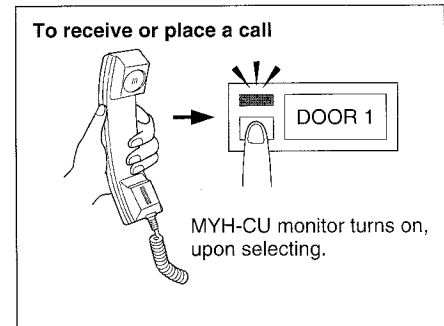

■ Calling an MY door station

1. Pick up TB-M handset, and press a designated button.
2. MYH-CU turns on. Pre-tone is heard at MY door station. The channel is established. Call by voice.
3. Communicate.

■ When called by MY door station, while communicating

1. A call-in LED is only lit. Image on MYH-CU remains unchanged.
2. To reply, press an LED-lit button, and the image is switched.

■ Selective & handsfree audio/visual monitoring

1. On TB-ADM10, press MONITOR button. The LED above is lit.
2. Within 5 seconds, press a designated button of MY door station you wish to monitor. The LED is lit.
3. MYH-CU turns on. Hear audio from TB-ADM10 speaker.
4. To call, pick up TB-M handset.

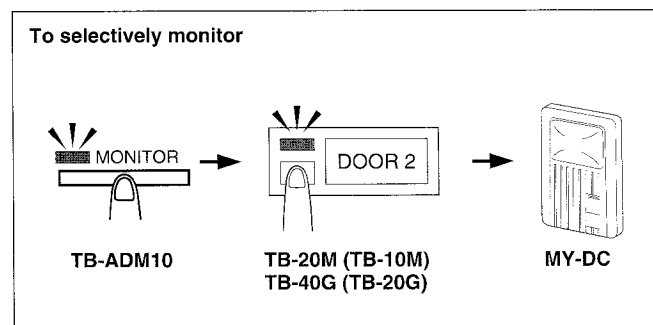

■ When called by MY door station during visual monitoring

1. Call-in LED is only lit, with audio call tone muted. The image is kept on.
2. Pick up TB-M handset. The channel to an MY door station being monitored is established.
3. Press a designated button of calling MY door station.
4. Image of calling MY comes on. Communicate.

- **Auto-scanning** – 60-minute handsfree audio-visual monitoring of MY door stations, skipping TB-SE and IE/IF audio door stations.

★ *With a duration of 10, 20 or 30 seconds, view image of MY door station in succession from top to bottom of TB-M switch bank, guided by a flashing of call-in LED.*

1. Press MONITOR button on TB-ADM10 for 2 sec. or more.
2. The attached LED turns on flashing. Image of MY door 1 comes on on Monitor TV (and MYH-CU). Audio is available from TB-ADM10.
3. After preset seconds, image of next door comes on, which will be stabilized in 2 seconds.
4. MYH-CU video monitor auto-turns off in 2-1/2 minutes.
5. To continue, view only on Monitor TV. Do not press any Monitor button. TB-ADM10 makes next rounds of scanning.
6. To conclude, press MONITOR button on TB-ADM10.
OR Auto-cancels after 60 minutes. Restart from 1.

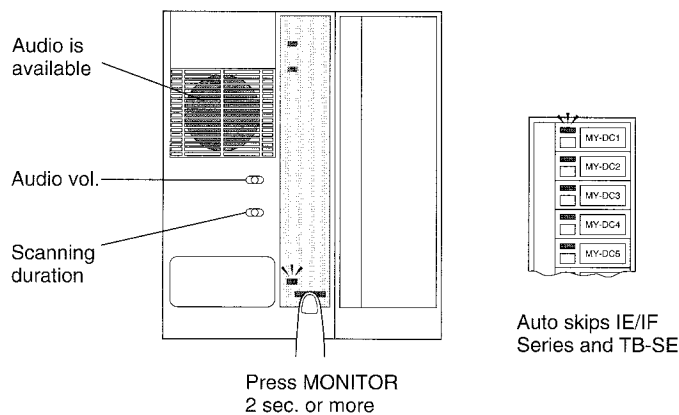

■ Receiving an MY door call during auto-scanning

1. Intermittent tremolo sounds from TB-M speaker.
2. Pick up TB-M handset, and press an LED-lit button.
3. Image of a calling MY comes on. Communicate.
4. Hang up handset to conclude.
5. Press MONITOR button on TB-ADM10 for 2 sec. or more to restart from MY1.

- ★ Auto-scanning is terminated by lifting handset on TB-M. It instantly establishes talk channel to an LED-lit MY door station. Calling is void from the MY just being scanned.

■ Presetting MY door camera angle

Any PanTilt MY door stations, except MY-DC, MY-DG, can change its initial center position to a desired camera angle, so that it turns back at each start/ end of operation.

To preset: - ★ Do not pick up TB-M handset.

1. Press a designated button of MY door on TB-M. See the call-in LED is lit.
2. Hold down BACKLIGHT button and press MONITOR once on MYH-CU. Keep holding down BACKLIGHT. *In about 5 seconds,*
3. See MYH-CU screen bottom (1/4) starts flashing. Release from BACKLIGHT. *It's ready to preset (or BACKLIGHT to cancel).*
4. Pan/tilt the camera to direct its angle to a standing point.
5. Lastly, press MONITOR button.

- ★ When an entire system is powered off, the preset memory can be erased. Reprogram.

■ Adjustments

- **Audio monitor volume** from TB-ADM10 speaker, adjustable or muted, while visual monitoring or auto-scanning.
- **Auto-scanning duration:** Set to either 10, 20 or 30 second from left.

7 TECHNICAL PRECAUTIONS

■ Video recording

- TB-ADM10 has CN9 video output connectable to a local Monitor TV or VCR (525 line only) with coaxial cable. Record video on VCR.(no audio) It is not an automatic recording.
- When a Time-Lapse VCR is connected with additional non-polar b, b wires to VCR's control terminals, all images on MYH-CU can be recorded automatically. (no audio)

■ Transfer of MY door call

It is not possible to transfer a call of MY or IE/IF door station. If TRANSFER switch is wrongly pressed, hang up TB-M handset, and press TRANSFER switch to clear.

■ Monitoring

For visual monitoring (any MY), always use MONITOR button on TB-ADM10.
To monitor IE/IF, press a designated button, lifting TB-M handset. TB-SE sub can never be monitored.

8 SPECIFICATIONS

- * **Power source:** 18V DC. Use a PS-18C or PS-18D power supply.
- * **Current consumption:** 700mA max. (TB-ADM10 only)
- * **No. of door stations.** 10 (max.) either PanTilt MY or IE/IF Series door stations.
- * **Call-in timer:** **40 seconds**
- * **Video timer:** **2-1/2 minutes**
- * **Auto-scanning timer:** **60 minutes**
- * **Wiring:** 2 conductors, non-polarized per door station
6 conductors, TB-ADM10 to MYH-CU
- * **Wiring distance:**

Distance \ Gauge	22AWG	18AWG	0.65mmø	1.0mmø
From TB-ADM10 to PanTilt MY	165'	330'	50m	100m
to MY-DS	330'	650'	100m	200m
to IE/IF audio	450'	1,180'	150m	360m

Distance \ Gauge	18AWG	16AWG	1.0mmø	1.2mmø
From TB-ADM10 to PS-18C or PS-18D	16'	33'	5m	10m

- * **Dimensions (H x W x D):** 92 x 195 x 230 (mm). 3-5/8" x 7-5/8" x 9"
- * **Weight:** 1.5kgs. (3.31 lbs.) approx.

This equipment has been tested and found to comply with the limits for a Class B digital device, pursuant to Part 15 of the FCC Rules. These limits are designed to provide reasonable protection against harmful interference in a residential installation. This equipment generates, uses, and can radiate radio frequency energy and, if not installed and used in accordance with the instructions, may cause harmful interference to radio communications. However, there is no guarantee that interference will not occur in a particular installation. If this equipment does cause harmful interference to radio or television reception, which can be determined by turning the equipment off and on, the user is encouraged to try to correct the interference by one or more of the following measures:

- Reorient or relocate the receiving antenna.
- Connect the equipment into an outlet on a circuit different from that to which the receiver is connected.
- Increase the separation between the equipment and receiver.
- Consult the dealer or an experienced radio/TV technician for help.

WARRANTY

Aiphone warrants its products to be free from defects of material and workmanship under normal use and service for a period of two years after delivery to the ultimate user and will repair free of charge or replace at no charge, should it become defective upon which examination shall disclose to be defective and under warranty. Aiphone reserves unto itself the sole right to make the final decision whether there is a defect in materials and/or workmanship; and whether or not the product is within the warranty.

This warranty shall not apply to any Aiphone product which has been subject to misuse, neglect, accident, or to use in violation of instructions furnished, nor extended to units which have been repaired or altered outside of the factory. This warranty does not cover batteries or damage caused by batteries used in connection with the product.

This warranty covers bench repairs only, and any repairs must be made at the shop or place designated in writing by Aiphone. Aiphone will not be responsible for any costs incurred involving on site service calls.

Aiphone Co., Ltd., Nagoya, Japan
Aiphone Corporation, Bellevue, WA, USA

TB-ADM10-I(E) 0795F

COMMUNICATION SYSTEMS
AIPHONE
HOME, BUSINESS, INDUSTRY.
Printed in Japan (E)