

# TWO STATION INTERCOM

Models: **TC-MB (Set)**  
**TC-MF (Master station)**

## — INSTRUCTIONS —

TC-MB (SET)

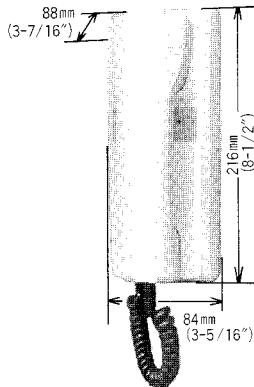

ROOM STATION  
TC-MF

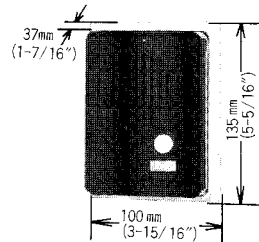

DOOR STATION  
IB-DB

- \* Simultaneous conversation.
- \* Electronic tone call signal with volume control.
- \* Long battery life due to low current requirement.
- \* LED indicator for easy checking of battery life.
- \* Power source: DC 6 volt. Four 1½ volt "C" batteries (room station incorporates battery compartment) or PS-6D power supply.
- \* Wiring and communication range: Single pair of wires — select the proper wire gauge to meet your requirements from the chart below.

Diameter of wire	0.65mm	0.8mm	20AWG	22AWG
Distance	150m	230m	750'	500'

### OPERATION

**Door station calling:**

Momentarily depress call button. Talk and listen hands free to master. Do not push call switch during conversation.

**Room station receiving:**

Pick up the handset and talk just as on a standard telephone.

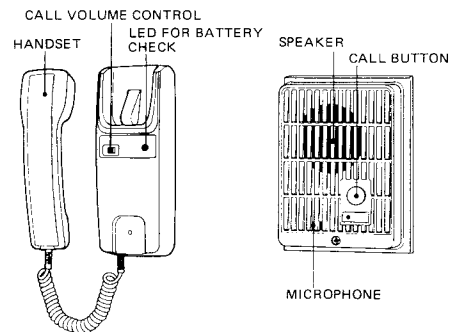

### INSTALLATION

- \* Connect terminal #1 on back of room station to terminal #1 on door station. Then connect terminal #2 on room station to terminal #2 on door station. **MAKE SURE YOUR WIRING IS CORRECT.** Incorrect wiring will not allow call tone or voice communication.
- \* Insert four 1.5V "C" batteries (not included) in battery compartment. + and - positioning of battery terminals is clearly indicated in the battery compartment.

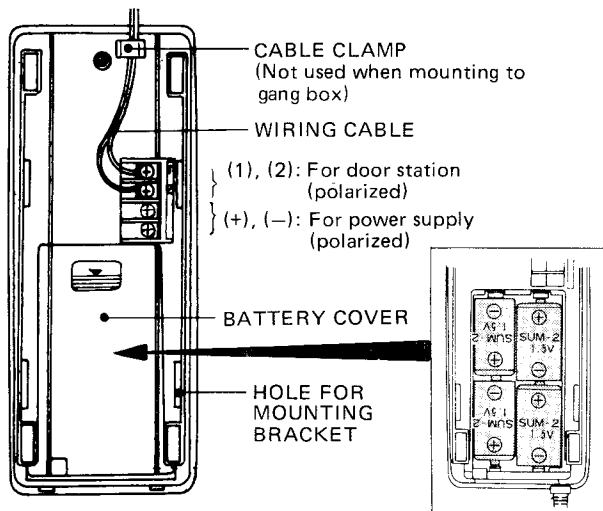
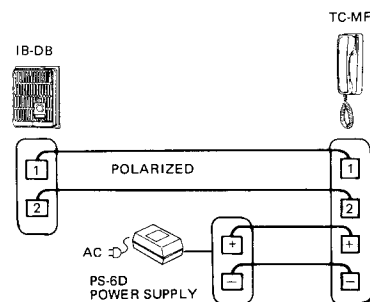

TC-MF BACK VIEW

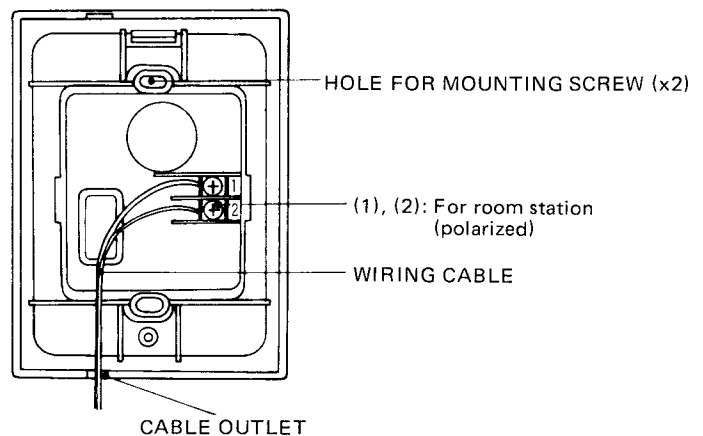

IB-DB BACK VIEW

## WALL MOUNTING INSTALLATION

### Room station:

Attach the mounting bracket with screws to wall or gang box. Insert the prongs of the bracket into the holes of the body and pull the body downward.

(Be careful not to attach the bracket upside down).

### Door station:

\* Attach bottom case to wall or gang box. Connect wires and insert front panel.

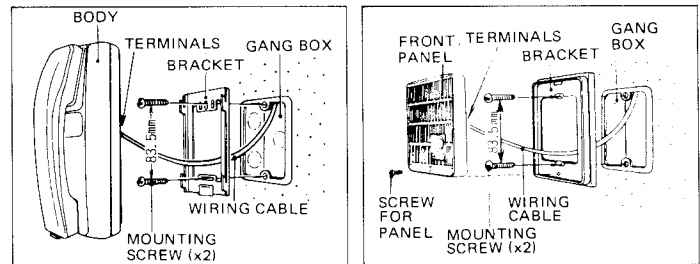

## ADJUSTING VOLUME CONTROL

The incoming call tone volume may be adjusted to three levels by setting switch as desired.

### TC-MF MASTER

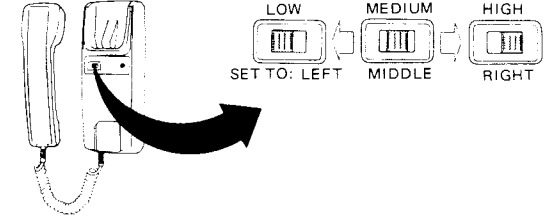

## LED FOR BATTERY CHECK

The system is designed for low current consumption providing longer battery life. Battery check LED is mounted on the TC-MF master.

### TC-MF MASTER

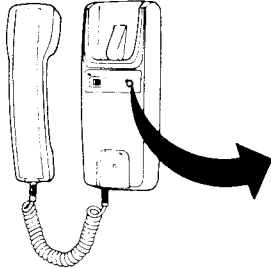

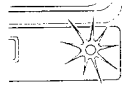
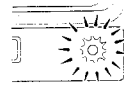
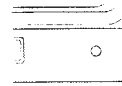
CONDITION #1	CONDITION #2	CONDITION #3
Lights normal during conversation. 	* Becomes dark during conversation. 	* Does not light during conversation. 
Batteries are powerful enough to function the system.	Batteries get weaker but don't have to be replaced yet.	Batteries are exhausted and must be replaced by new ones.

## BEFORE YOU INSTALL AND OPERATE THE EQUIPMENT – Prohibitions and precautions –

### \* Operation;

1. DO NOT HOLD HOOK SWITCH DOWN WHILE PICKING UP HANDSET. THE CALL TONE SOUNDS THRU THE HANDSET RECEIVER ELEMENT AND COULD CAUSE HEARING DAMAGE.

### \* Installation;

1. DO NOT CONNECT ANY TERMINAL ON ANY UNIT TO AC POWER LINES.
2. Be sure to remove plug of power supply from AC outlet before you open the unit or make wiring connections.
3. Avoid running the connecting wires thru doors, windows or between furniture, which may pinch and disconnect the wires.
4. The intercom equipment must be installed in as dry and dust-free environment as possible.

### \* Maintenance;

1. Clean your intercom equipment with a soft cloth dampened with neutral household cleanser. Never use thinner nor benzine, etc.
2. Do not splash water on the door station by hose, etc.

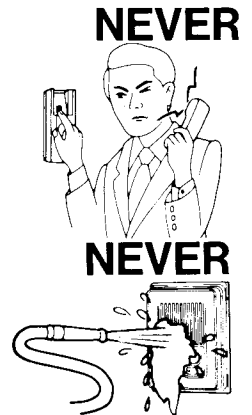

\* \* \*

We at AIPHONE are proud of our products. Our designers and engineers strive to bring you the finest in communication equipment. Each item has been carefully tested and inspected before leaving our factory. Properly installed and used, your Aiphone intercom system should give years of trouble-free service.

### WARRANTY

Aiphone warrants its products to be free from defects of material and workmanship under normal use and service for a period of one year after delivery to the ultimate user and will repair free of charge or replace at no charge, should it become defective upon which examination shall disclose to be defective and under warranty. Aiphone reserves unto itself the sole right to make the final decision whether there is a defect in materials and or workmanship; and whether or not the product is within the warranty.

This warranty shall not apply to any Aiphone product which has been subject to misuse, neglect, accident, or to use in violation of instructions furnished, nor extended to units which have been repaired or altered outside of the factory.

This warranty does not cover batteries or damage caused by batteries used in connection with the product.

This warranty covers bench repairs only, and any repairs must be made at the shop or place designated in writing by Aiphone. Aiphone will not be responsible for any costs incurred involving on site service calls.