

## APARTMENT HOUSE INTERCOM SYSTEM

**VAM :** DOOR STATION

**VA-K :** APARTMENT STATION

### — INSTRUCTIONS —

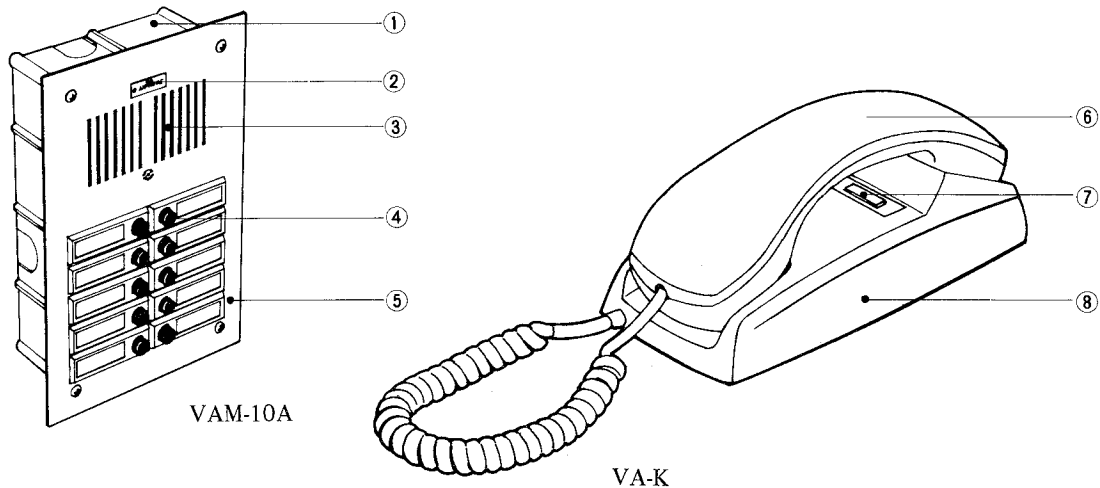

#### NAMES AND FUNCTIONS:

- |                                        |                       |
|----------------------------------------|-----------------------|
| ① Back box                             | ⑤ Front panel         |
| ② AIPHONE plate w/LED                  | ⑥ Handset             |
| ③ Speaker, microphone w/amplifier unit | ⑦ Door release switch |
| ④ Call button w/directory              | ⑧ Body                |

#### SPECIFICATIONS:

- \* Power source: DC 12 volt. Use PS-12S (PS-12C in N. America) power supply.
- \* Current consumption: 100 mA maximum.
- \* Calling: Push button selection at door station. An electronic tone sounds in the suite, when selector button is depressed.
- \* Communication: Hands free loudspeaking at door station.  
Simultaneous conversation telephone-type room station.
- \* Riser wiring: 6 common plus 1 per suite (less 2 wires if door release function is not required).

#### FEATURES:

- \* Simple operation; telephone-type station in suite and hands free loudspeaker at door.
- \* One power supply only needed to supply communication power and door release power.
- \* Call button panel available for additional suite selections.

## EQUIPMENT AVAILABLE FOR USE WITH YOUR APARTMENT HOUSE INTERCOM:

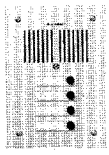

VAM- : Door station for apartment building of 4 suites or less (Not available in North America).  
 VAM-0: Includes no call buttons.  
 VAM-1: Includes 1 call button.  
 VAM-2: Includes 2 call buttons.  
 VAM-3: Includes 3 call buttons.  
 VAM-4: Includes 4 call buttons.

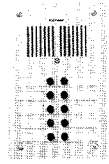

VAM-A: Door station for apartment building of 6 suites or more.  
 VAM-0A: Includes no call buttons.  
 VAM-6A: Includes 6 call buttons.  
 VAM-8A: Includes 8 call buttons.  
 VAM-10A: Includes 10 call buttons.

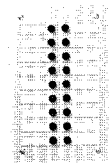

VBK- : Call button panel for additional suite selections. Designed for use with VAM-A type door station.  
 VBK-10: Includes 10 call buttons (Not available in North America).  
 VBK-18: Includes 18 call buttons.

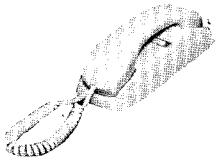

VA-K: Apartment telephone. Includes button to operate door release.



EL-9S: Door release.



PS-12S: Power supply. Provides power for both communication and door release operation (Not available in North America).



PS-12C: Power supply. Provides power for communication only (Available only in North America).

## INSTALLATION:

Do not attempt to install your intercom system until you have read and thoroughly understood the installation procedure. Aiphone's warranty is void if system is installed in a manner other than as described in this manual.

### APARTMENT STATION INSTALLATION:

- 1) Remove the screw and separate cover from bottom case.
- 2) Attach bottom case to 1-gang box with two screws.
- 3) Wire terminals and remount cover to bottom case.

NOTE: If box is not provided, bottom case may be mounted directly to wall with three screws (shown by A in the drawing). Wire cord may be pulled out either from top or bottom of the body.

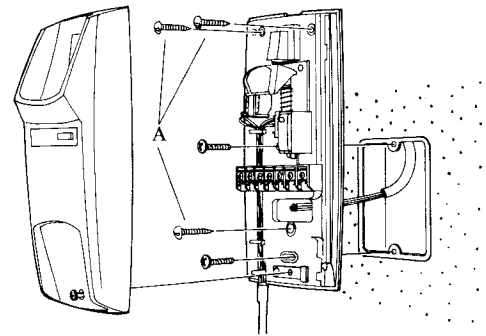

### DIMENSIONS:

	Width	Height	Depth
VAM back box	129 mm (5-1/8)	186 mm (7-5/16)	66 mm (2-9/16)
VAM panel	160 mm (6-5/16)	220 mm (8-11/16)	2 mm (3/4)
VAM-A & VBK back box	136 mm (5-3/8)	230 mm (9-1/16)	66 mm (2-9/16)
VAM-A & VBK panel	170 mm (6-11/16)	260 mm (10-1/4)	2 mm (3/4)
VA-K	92 mm (3-5/8)	93 mm (3-11/16)	220 mm (8-11/16)

## WIRING:

Lay out your system in advance. We recommend that spare conductors be included in each riser to eliminate the possibility of removing all of the cable should a conductor prove defective.

Wiring is simple and straight forward. Refer to the drawing and make connections as indicated. 'B' terminal on each phone completes ring circuit to door station and is the only wire in the riser that is not common. Connect 'B' wire from each phone to whichever push button you desire at door station to provide a directory layout that meets your requirements.

Refer to the chart below and select the proper gauge wire to meet your requirements.

AWG WIRE SIZE	22 AWG	20 AWG	18 AWG
DISTANCE	1100'	1650'	2500'
DIAMETER OF WIRE	0.65 mm	0.8 mm	1.0 mm
DISTANCE	330 m	500 m	800 m

NOTE: If 0.65 mm dia. (22 AWG) wire is used, we suggest that 2 conductors be used on each L & L terminal to give more current to electric strike.

## INSTALLATION HINTS:

As most apartment buildings are "stacked" (units above and below are identical) it is recommended that each "stack" or "riser" be wired separately. Starting with the unit on the top floor, run a cable down through each unit to the bottom, then on to a termination point, i.e., electrical or mechanical room. Repeat this cable run for each riser. The number of riser cables required is determined by the number of apartments per floor.

The number of conductors required in each of these riser cables will be 6, plus one for each apartment in the riser. It is recommended that 2 extra conductors be included as spares.

When the riser wiring has been completed it is recommended that a multiconductor cable be run from point of termination to door station. The 6 conductors of each riser cable are common to the entire system, they supply communications and door release. The individual apartment wires are for signaling each unit, and must be run to door station buttons. This multiconductor cable must contain 1 wire per apartment plus 6, (spare conductors are recommended) refer to diagram for proper connections. Power supply would be normally located at point of termination.

On smaller buildings it may be desirable to run riser cables directly to the door station.

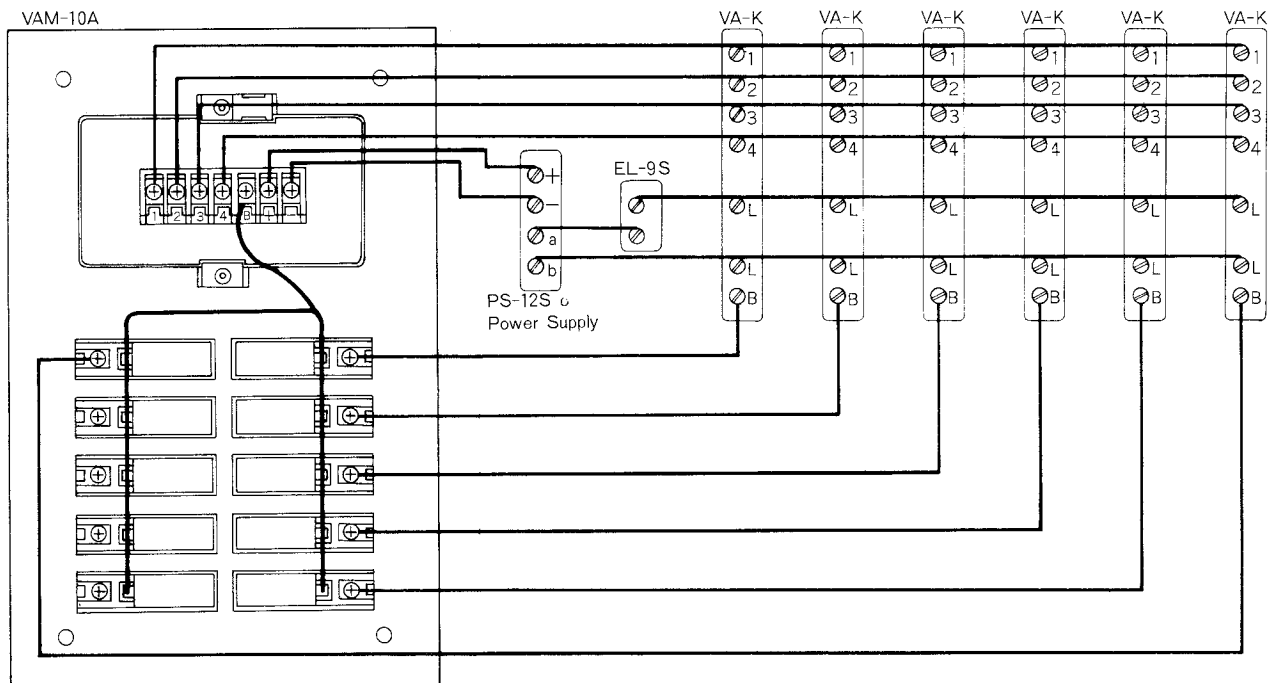

NOTE: If EL-9S electric door release is not installed, you do not need to wire L, L terminals on each VA-K station.

## INSTALLING ELECTRIC DOOR RELEASE:

Aiphone offers the EL-9S electric door release for general purpose use. You may find, however, that your particular installation requires a special size or style door release.

Your Apartment House Intercom system will operate door releases manufactured by others. It is recommended you do not exceed 48 V 10 Amp. A separate power source must be used if more than 10 V AC is required. Conductors normally connected to a & b on PS-12S power supply would then be connected to separate power source.

## AVAILABLE CYLINDRICAL LOCKS

The bolt width should be within 28mm (1 1/8")

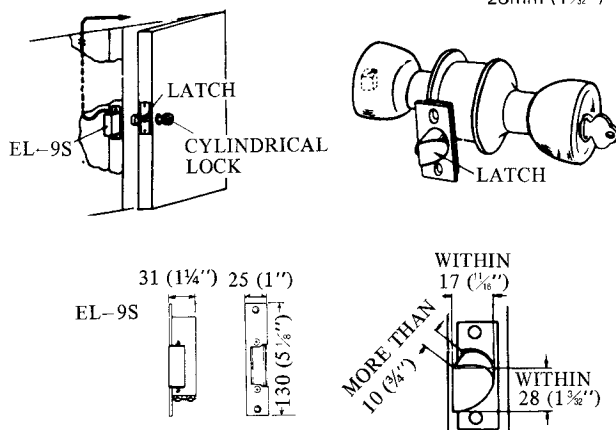

## OPERATION:

### Door Station:

- Calling: Depress the selector button of the suite you wish to call.
- Talking: Once suite answers communication is hands free..

### Room Station:

- Receiving: Upon hearing call signal, pick up handset and talk just as you would on an ordinary telephone.
- Door release: To open door depress provided push button. Release will remain activated only when button is depressed.

## CLEANING YOUR INTERCOM STATIONS:

Your Aiphone intercom stations may be cleaned with a soft cloth dampened with non-abrasive household cleanser, such as Mr. Clean or Fantastik.

We at Aiphone are proud of our products. Our designers and engineers strive to bring you the finest in communication equipment. Each item has been carefully tested and inspected before leaving our factory. Properly installed and used, your Aiphone intercom system should give years of trouble-free service.

We are pleased to offer the following warranty:

### WARRANTY

Aiphone warrants its products to be free from defects of material and workmanship under normal use and service for a period of one year after delivery to the ultimate user and will repair free of charge or replace at no charge, should it become defective upon which examination shall disclose to be defective and under warranty. Aiphone reserves unto itself the sole right to make the final decision whether there is a defect in materials and/or workmanship; and whether or not the product is within the warranty.

This warranty shall not apply to any Aiphone product which has been subject to misuse, neglect, accident, or to use in violation of instructions furnished, nor extended to units which have been repaired or altered outside of the factory.

This warranty does not cover batteries or damage caused by batteries used in connection with the product.

This warranty covers bench repairs only, and any repairs must be made at the shop or place designated in writing by Aiphone. Aiphone will not be responsible for any costs incurred involving on site service calls.

Aiphone Co., Ltd., Nagoya, Japan  
Aiphone Corporation, Bellevue, Washington

ALL OVER THE WORLD **AIPHONE**

Printed in Japan

VAM-1